



<http://www.ebiz-tcf.eu>

## IMPLEMENTATION GUIDE

includes COMPARISON BETWEEN CURRENT and LAST  
PREVIOUSLY RELEASED VERSION  
TRANSACTION "FASHION CATALOGUE"

Version: v2018-1

Date of release: 18/7/2019

Document code: G080rv

technical Documentation: <http://www.ebiz.enea.it>

XML Schemas repository: <http://www.ebiz.enea.it/moda-ml/repository/schema/v2018-1/default.asp>

Guides repository: <http://www.ebiz.enea.it/moda-ml/repository/guide/v2018-1/default.asp>

Guide filename: G080rv-eBIZ-FashionCatalogue.pdf

# 1. BUSINESS DESCRIPTION

## 1.1 Scope

The present guide has been issued to assist the companies of the Fashion sector in the implementation of the standard XML document type "FASHION CATALOGUE", providing all the instruction required for its use in any context of e-commerce between Fashion Producers and their customers and eBusiness and eCommerce platforms.

All the rules required for the construction and validation of the document are embedded into the specific XML-Schema, which is detailed in section "Implementation guide".

## 1.2 Generalities

This document is usable as a catalog (showcase / offer) as well as to exchange in advance the product data between Suppliers and Customers, in order to allow the synchronization of the corresponding data-base. . Furthermore, a Producer can use it to publish is offer on ePlatforms.

It contains the items that compose the Fashion Manufacturer's offer (codes, descriptions, prices and terms of sale) and may include some technical-descriptive data of the product (trade name, composition, weight and height, . . .) as well as marketing information (images, verbose descriptions, . . .)

## 1.3. Possible scenario

Initial transmission of information to eService

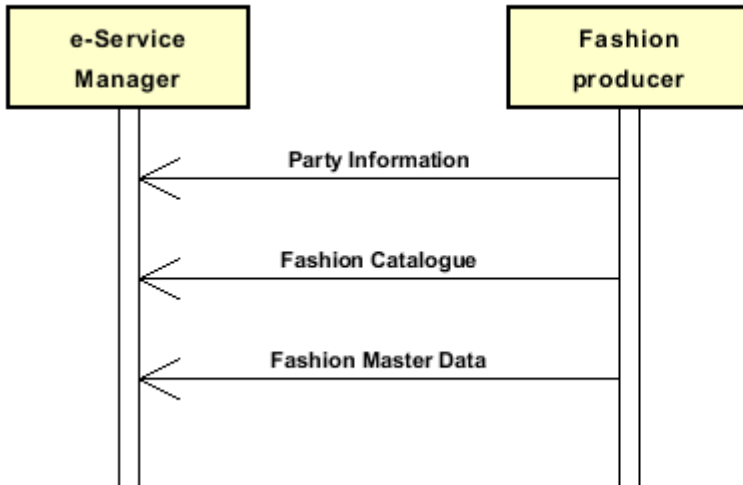

## 2. IMPLEMENTATION GUIDE

### 2.1 General structure of XML document

All the business data that can be exchanged through this class of documents are shown in the following "document structure", that provides a simplified vision of the Schema.

In particular:

- the two numbers following each element define its "cardinality" (minimum and maximum number of occurrences); the minimum equal zero indicates that the element is optional, the minimum greater than zero indicates that is mandatory;
- the bold character denotes the complex elements (aggregates of simple elements) that were built for the sake of functionality and re-usability of some complex informations sets. The child elements in each parent element are easily spotted as "indented";
- the symbol "@" denotes an attribute of the preceding element; here "the usage indicator (optional, required, ...) is shown in square brackets.

#### Legenda

- N: new element
- U: updated properties
- P: changes in children
- p: is a changed child
- A: changes in attributes
- a: is a new or changed attribute
- \*: is a subtype

### Structure

#### FASCatalog (N\*)

@version [Optional] [Default= 2018-1]

@useProfile [Optional]

```
| FCheader 1-1 (N*)
| | msgN 1-1
| | msgID 0-1
| | msgDate 1-1
| | @dateForm [Optional]
| | msgCurrency 0-1
| | refDoc 0-9 (P)
| | @docType [Required]
| | | docID 1-2 (p)
| | | @numberingOrg [Optional]
| | | docDate 0-1
| | | @dateForm [Optional]
| | | season 0-1 (A)
| | | @numberingOrg [Optional] (a)
| | | @codeList [Optional] (a)
| | | @listName [Optional] (a)
| | | @listVersion [Optional] (a)
| | | itemID 0-1 (U)
| | | attachment 0-1 (N)
| | | @uid [Optional]
| | | | fileName 0-1 (N)
| | | | @numberingOrg [Optional] (a)
| | | | binaryObject 0-1 (N)
| | | | @format [Optional] (Na)
| | | | @mime [Optional] (Na)
| | | | @encoding [Optional] (Na)
| | | | @characterSet [Optional] (Na)
```

- | | | | **externalReference 0-99** (N)
  - | | | | uri 1-1 (N)
  - | | | | @isURL [Optional] [Default= true] (Na)
  - | | | | mimeTypeCode 0-1 (N)
  - | | | | formatCode 0-1 (N)
  - | | | | encodingCode 0-1 (N)
  - | | | | characterSetCode 0-1 (N)
- | **picture 0-9** (N\*)
  - | pictureCode 0-1 (N\*)
  - | title 0-unbounded (N)
  - | @In [Optional] (Na)
  - | description 0-unbounded (AU)
  - | @In [Optional] (N)
  - | validityStart 0-1
  - | @dateForm [Optional]
  - | validityEnd 0-1
  - | @dateForm [Optional]
  - | alternativeText 0-unbounded (N\*)
  - | @In [Optional] (Na)
  - | rendering 0-1 (N\*)
  - | resolution 0-1 (N\*)
  - | @resolutionType [Optional] [Default= dpi] (Na)
  - | width 0-1
  - | @um [Required]
  - | height 0-1
  - | @um [Required]
  - | nominalWidth 0-2 (N\*)
  - | @um [Optional] (a)
  - | nominalHeight 0-2 (N\*)
  - | @um [Optional] (a)
  - | pictureUse 0-1 (N\*)
  - | pictureQualifier 0-1 (N\*)
  - | **attachment 1-1** (N)
    - | @uid [Optional]
    - | fileName 0-1 (N)
    - | @numberingOrg [Optional] (a)
    - | binaryObject 0-1 (N)
    - | @format [Optional] (Na)
    - | @mime [Optional] (Na)
    - | @encoding [Optional] (Na)
    - | @characterSet [Optional] (Na)
    - | **externalReference 0-99** (N)
      - | uri 1-1 (N)
      - | @isURL [Optional] [Default= true] (Na)
      - | mimeTypeCode 0-1 (N)
      - | formatCode 0-1 (N)
      - | encodingCode 0-1 (N)
      - | characterSetCode 0-1 (N)
  - | note 0-99
    - | @numberingOrg [Optional]
    - | @codeList [Optional]
    - | @noteLabel [Optional]
- | season 0-1 (A)
  - | @numberingOrg [Optional] (a)
  - | @codeList [Optional] (a)
  - | @listName [Optional] (a)
  - | @listVersion [Optional] (a)
  - | validityStart 0-1
  - | @dateForm [Optional]
  - | validityEnd 0-1
  - | @dateForm [Optional]

**buyer 0-1** (APp)  
@logo [Optional]  
@sender [Optional] (a\*)  
| id 1-1 (p)  
| | @numberingOrg [Optional]  
| additionalIdentifier 0-9 (N)  
| | @numberingOrg [Optional] (a)  
| | @idQualifier [Optional] (Na)  
| legalName 0-1 (U)  
| dept 0-1  
| subDept 0-1 (N)  
| person 0-1  
| | @email [Optional]  
| | @phone [Optional]  
| | @fax [Optional]  
| street 0-1  
| city 0-1  
| subCountry 0-1  
| country 0-1  
| postCode 0-1

**supplier 1-1** (APp)  
@logo [Optional]  
@sender [Optional] (a\*)  
| id 1-1  
| | @numberingOrg [Optional]  
| additionalIdentifier 0-9 (N)  
| | @numberingOrg [Optional] (a)  
| | @idQualifier [Optional] (Na)  
| legalName 0-1 (U)  
| dept 0-1  
| subDept 0-1 (N)  
| person 0-1  
| | @email [Optional]  
| | @phone [Optional]  
| | @fax [Optional]  
| street 0-1  
| city 0-1  
| subCountry 0-1  
| country 0-1  
| postCode 0-1

**thirdParty 0-5** (AP)  
@VAT [Optional]  
@role [Required]  
@sender [Optional] (a\*)  
| id 1-1  
| | @numberingOrg [Optional]  
| legalName 0-1 (U)  
| dept 0-1  
| subDept 0-1 (N)  
| person 0-1  
| | @email [Optional]  
| | @phone [Optional]  
| | @fax [Optional]  
| street 0-1  
| city 0-1  
| subCountry 0-1  
| country 0-1  
| postCode 0-1

note 0-99  
| @numberingOrg [Optional]  
| @codeList [Optional]

```

| | @noteLabel [Optional]
|
| terms 0-1 (P)
| | payment 0-5
| | @finDiscount [Optional]
| | @finSurcharge [Optional]
| | - choose -
| | | payTerm 1-1
| | | - or -
| | | payTermText 1-1 (U)
| | | - end choose -
| | | payMode 0-1
| | insPayment 0-5
| | @part [Required]
| | - choose -
| | | payTerm 1-1
| | | - or -
| | | payTermText 1-1 (U)
| | | - end choose -
| | | payMode 0-1
| | trade 0-1
| | - choose -
| | | incoTermText 1-1 (U)
| | | - or -
| | | incoTerm 1-1
| | | - end choose -
| | | location 0-1
| | | @LRI [Optional]
| | transInfo 0-5 (pAP)
| | @transReason [Optional]
| | @progr [Optional] (N)
| | | transMode 1-1
| | | carrier 0-1
| | | deliveryPlace 0-1 (U)
| | | grossWeight 0-1
| | | @um [Required]
| | | netWeight 0-1
| | | @um [Required]
| | | transMeans 0-1
| | | transCondition 0-3
| | | transConditionText 0-1 (U)
| | | despatchPlace 0-1 (N)
| | | despatchDate 0-1 (N)
| | | @dateForm [Optional] (a)
| | | delEffectiveDate 0-1 (p)
| | | @dateForm [Optional]
| | allowanceCharge 0-9 (A)
| | @um [Optional] (a)
| | @VAT [Optional]
| | @minQty [Optional] (a)
| | @currency [Optional] (a)
| | @maxQty [Optional] (N)
| | @isCharge [Optional] (N)
| | - choose -
| | | AC_category 1-1
| | | - or -
| | | AC_categoryText 1-1 (U)
| | | - end choose -
| | | - choose -
| | | AC_percent 1-1
| | | - or -

```

- | | | AC\_amount 1-1 (A)
- | | | @currency [Optional] (a)
- | - end choose -
- | | | **dtScheme 0-1** (P)
- | | | @taxType [Required]
- | | | taxCategory 0-1
- | | | taxRate 0-1
- | | | legalRef 0-1 (A)
- | | | @numberingOrg [Optional] (a)
- | | | @codeList [Optional] (a)
- | | | @listName [Optional] (a)
- | | | @listVersion [Optional] (a)
- | | | note 0-99
- | | | @numberingOrg [Optional]
- | | | @codeList [Optional]
- | | | @noteLabel [Optional]

- | **garComInfo 0-1** (N\*)
- | @endUse [Optional] (a)
- | | season 0-1 (A)
- | | | @numberingOrg [Optional] (a)
- | | | @codeList [Optional] (a)
- | | | @listName [Optional] (a)
- | | | @listVersion [Optional] (a)
- | | brand 0-1 (N)
- | | | @numberingOrg [Optional] (a)
- | | | @codeList [Optional] (a)
- | | | @listName [Optional] (a)
- | | | @listVersion [Optional] (a)
- | | productLine 0-1 (N)
- | | | @numberingOrg [Optional] (a)
- | | | @codeList [Optional] (a)
- | | | @listName [Optional] (a)
- | | | @listVersion [Optional] (a)
- | | project 0-1 (U)
- | | operationalCode 0-19 (N)
- | | | @numberingOrg [Optional] (a)
- | | | @codeList [Optional] (a)
- | | | @listName [Optional] (a)
- | | | @listVersion [Optional] (a)
- | | | @codeQualifier [Optional] (Na)
- | | deliveryDate 0-1 (p)
- | | | @dateForm [Optional]
- | | specDate 0-1 (p)
- | | | @dateForm [Optional]

- choose -

- | | **yarnPack 0-1** (p)
- | | | **yarnReel 1-1**
- | | | | @reelType [Required]
- | | | | @reelMat [Optional]
- | | | | yarnReelD 0-1
- | | | | | @um [Required]
- | | | | yarnReelH 0-1
- | | | | | @um [Required]
- | | | | yarnConeAngle 0-1
- | | | | yarnReelQty 0-2
- | | | | | @um [Required]
- | | | | label 0-1
- | | | | labelWrit 0-1
- | | | **yarnInWrap 0-1**
- | | | | yarnReelWrap 1-1

```

| | | | label 0-1
| | | | labelWrit 0-1
| | | - choose -
| | | | yarnOutWrapText 0-1 (U)
| | | - or -
| | | | yarnOutWrap 0-1
| | | - end choose -
| | | - or -
| | | piecePack 0-1 (P)
| | | - choose -
| | | | piecePackText 1-1 (U)
| | | - or -
| | | | pieceInnWrap1 1-1
| | | | pieceInnWrap2 0-1
| | | | pieceOutWrap 0-1
| | | - end choose -
| | | - or -
| | | acsPack 0-1 (U)
| | | - choose -
| | | | acsPackCode 1-1 (AU)
| | | | | @numberingOrg [Optional] (a)
| | | | | @codeList [Optional] (a)
| | | | | @listName [Optional] (a)
| | | | | @listVersion [Optional] (a)
| | | - or -
| | | | acsPackText 1-1 (U)
| | | - end choose -
| | | - or -
| | | garPack 0-1 (N)
| | | - choose -
| | | | garPackCode 1-1 (N)
| | | | | @numberingOrg [Optional] (a)
| | | | | @codeList [Optional] (a)
| | | | | @listName [Optional] (a)
| | | | | @listVersion [Optional] (a)
| | | - or -
| | | | garPackText 1-1 (N)
| | | - end choose -
| | | - end choose -
| | | note 0-99
| | | | @numberingOrg [Optional]
| | | | @codeList [Optional]
| | | | @noteLabel [Optional]
| FCbody 1-1 (N*)
| | FCgroup 1-unbounded (N)
| | | artGroup 0-1
| | | | @numberingOrg [Optional]
| | | | @codeList [Optional]
| | | | @listName [Optional]
| | | | @listVersion [Optional]
| | | | artGroupName 0-1 (U)
| | | | description 0-unbounded (AU)
| | | | | @In [Optional] (N)
| | | | extendedDescription 0-unbounded (N)
| | | | | @In [Optional] (Na)
| | | | refDoc 0-9 (P)
| | | | | @docType [Required]
| | | | | | docID 1-2 (P)
| | | | | | @numberingOrg [Optional]
| | | | | docDate 0-1

```



@dateForm [Optional]  
 season 0-1 (A)  
 @numberingOrg [Optional] (a)  
 @codeList [Optional] (a)  
 @listName [Optional] (a)  
 @listVersion [Optional] (a)  
 itemID 0-1 (U)  
**attachment 0-1** (N)  
 @uid [Optional]  
 | fileName 0-1 (N)  
 | @numberingOrg [Optional]  
 | binaryObject 0-1 (N)  
 | @format [Optional] (N)  
 | @mime [Optional] (N)  
 | @encoding [Optional] (N)  
 | @characterSet [Optional] (N)  
**externalReference 0-99** (N)  
 | uri 1-1 (N)  
 | @isURL [Optional] [Default= true] (Na)  
 | mimeTypeCode 0-1 (N)  
 | formatCode 0-1 (N)  
 | encodingCode 0-1 (N)  
 | characterSetCode 0-1 (N)  
**picture 0-99** (N\*)  
 | pictureCode 0-1 (N\*)  
 | title 0-unbounded (N)  
 | @ln [Optional] (Na)  
 | description 0-unbounded (AU)  
 | @ln [Optional] (N)  
 | validityStart 0-1  
 | @dateForm [Optional]  
 | validityEnd 0-1  
 | @dateForm [Optional]  
 | alternativeText 0-unbounded (N\*)  
 | @ln [Optional] (Na)  
 | rendering 0-1 (N\*)  
 | resolution 0-1 (N\*)  
 | @resolutionType [Optional] [Default= dpi] (Na)  
 | width 0-1  
 | @um [Required]  
 | height 0-1  
 | @um [Required]  
 | nominalWidth 0-2 (N\*)  
 | @um [Optional] (a)  
 | nominalHeight 0-2 (N\*)  
 | @um [Optional] (a)  
 | pictureUse 0-1 (N\*)  
 | pictureQualifier 0-1 (N\*)  
**attachment 1-1** (N)  
 @uid [Optional]  
 | fileName 0-1 (N)  
 | @numberingOrg [Optional]  
 | binaryObject 0-1 (N)  
 | @format [Optional] (N)  
 | @mime [Optional] (N)  
 | @encoding [Optional] (N)  
 | @characterSet [Optional] (N)  
**externalReference 0-99** (N)  
 | uri 1-1 (N)  
 | @isURL [Optional] [Default= true] (Na)  
 | mimeTypeCode 0-1 (N)

				formatCode 0-1 (N)
				encodingCode 0-1 (N)
				characterSetCode 0-1 (N)
				note 0-99
				@numberingOrg [Optional]
				@codeList [Optional]
				@noteLabel [Optional]
				<b>allowanceCharge 0-9 (A)</b>
				@um [Optional] (a)
				@VAT [Optional]
				@minQty [Optional] (a)
				@currency [Optional] (a)
				@maxQty [Optional] (N)
				@isCharge [Optional] (N)
				- choose -
				AC_category 1-1
				- or -
				AC_categoryText 1-1 (U)
				- end choose -
				- choose -
				AC_percent 1-1
				- or -
				AC_amount 1-1 (A)
				@currency [Optional]
				- end choose -
				<b>dtScheme 0-1 (P)</b>
				@taxType [Required]
				taxCategory 0-1
				taxRate 0-1
				legalRef 0-1 (A)
				@numberingOrg [Optional] (a)
				@codeList [Optional] (a)
				@listName [Optional] (a)
				@listVersion [Optional] (a)
				note 0-99
				@numberingOrg [Optional]
				@codeList [Optional]
				@noteLabel [Optional]
				<b>garComInfo 0-1 (N*)</b>
				@endUse [Optional] (a)
				season 0-1 (A)
				@numberingOrg [Optional] (a)
				@codeList [Optional] (a)
				@listName [Optional] (a)
				@listVersion [Optional] (a)
				brand 0-1 (N)
				@numberingOrg [Optional] (a)
				@codeList [Optional] (a)
				@listName [Optional] (a)
				@listVersion [Optional] (a)
				productLine 0-1 (N)
				@numberingOrg [Optional] (a)
				@codeList [Optional] (a)
				@listName [Optional] (a)
				@listVersion [Optional] (a)
				project 0-1 (U)
				operationalCode 0-19 (N)
				@numberingOrg [Optional] (a)
				@codeList [Optional] (a)
				@listName [Optional] (a)
				@listVersion [Optional] (a)

```

| | | | @codeQualifier [Optional] (Na)
| | | | deliveryDate 0-1 (p)
| | | | @dateForm [Optional]
| | | | specDate 0-1 (p)
| | | | @dateForm [Optional]
| | | - choose -
| | | | yarnPack 0-1 (p)
| | | | | yarnReel 1-1
| | | | | | @reelType [Required]
| | | | | | @reelMat [Optional]
| | | | | | | yarnReelD 0-1
| | | | | | | | @um [Required]
| | | | | | | yarnReelH 0-1
| | | | | | | | @um [Required]
| | | | | | | yarnConeAngle 0-1
| | | | | | | yarnReelQty 0-2
| | | | | | | | @um [Required]
| | | | | | | label 0-1
| | | | | | | labelWrit 0-1
| | | | | | yarnInWrap 0-1
| | | | | | | yarnReelWrap 1-1
| | | | | | | label 0-1
| | | | | | | labelWrit 0-1
| | | | - choose -
| | | | | yarnOutWrapText 0-1 (U)
| | | | - or -
| | | | | yarnOutWrap 0-1
| | | | - end choose -
| | | - or -
| | | | piecePack 0-1 (p)
| | | | - choose -
| | | | | piecePackText 1-1 (U)
| | | | - or -
| | | | | pieceInnWrap1 1-1
| | | | | pieceInnWrap2 0-1
| | | | | pieceOutWrap 0-1
| | | | - end choose -
| | | - or -
| | | | acsPack 0-1 (U)
| | | | - choose -
| | | | | acsPackCode 1-1 (AU)
| | | | | | @numberingOrg [Optional]
| | | | | | @codeList [Optional]
| | | | | | @listName [Optional]
| | | | | | @listVersion [Optional]
| | | | | - or -
| | | | | | acsPackText 1-1 (U)
| | | | | - end choose -
| | | | - or -
| | | | | garPack 0-1 (N)
| | | | | - choose -
| | | | | | garPackCode 1-1 (N)
| | | | | | | @numberingOrg [Optional]
| | | | | | | @codeList [Optional]
| | | | | | | @listName [Optional]
| | | | | | | @listVersion [Optional]
| | | | | | - or -
| | | | | | | garPackText 1-1 (N)
| | | | | | - end choose -
| | | | - end choose -
| | | | note 0-99

```

| | | @numberingOrg [Optional]

| | | @codeList [Optional]

| | | @noteLabel [Optional]

| | **FCitem 0-unbounded** (N)

| | lineN 0-1

| | | @VAT [Optional]

| | lineID 0-1 (N)

| | **refDoc 0-9** (P)

| | | @docType [Required]

| | | docID 1-2 (p)

| | | | @numberingOrg [Optional]

| | | docDate 0-1

| | | | @dateForm [Optional]

| | | season 0-1 (A)

| | | | @numberingOrg [Optional] (a)

| | | | @codeList [Optional] (a)

| | | | @listName [Optional] (a)

| | | | @listVersion [Optional] (a)

| | | itemID 0-1 (U)

| | | **attachment 0-1** (N)

| | | | @uid [Optional]

| | | | | fileName 0-1 (N)

| | | | | | @numberingOrg [Optional] (a)

| | | | | binaryObject 0-1 (N)

| | | | | | @format [Optional] (Na)

| | | | | | @mime [Optional] (Na)

| | | | | | @encoding [Optional] (Na)

| | | | | | @characterSet [Optional] (Na)

| | | | **externalReference 0-99** (N)

| | | | | uri 1-1 (N)

| | | | | | @isURL [Optional] [Default= true] (Na)

| | | | | mimeCode 0-1 (N)

| | | | | formatCode 0-1 (N)

| | | | | encodingCode 0-1 (N)

| | | | | characterSetCode 0-1 (N)

| | **picture 0-99** (N\*)

| | | pictureCode 0-1 (N\*)

| | | title 0-unbounded (N)

| | | | @In [Optional] (Na)

| | | description 0-unbounded (AU)

| | | | @In [Optional] (N)

| | | validityStart 0-1

| | | | @dateForm [Optional]

| | | validityEnd 0-1

| | | | @dateForm [Optional]

| | | alternativeText 0-unbounded (N\*)

| | | | @In [Optional] (N)

| | | rendering 0-1 (N\*)

| | | resolution 0-1 (N\*)

| | | | @resolutionType [Optional] [Default= dpi] (N)

| | | width 0-1

| | | | @um [Required]

| | | height 0-1

| | | | @um [Required]

| | | nominalWidth 0-2 (N\*)

| | | | @um [Optional]

| | | nominalHeight 0-2 (N\*)

| | | | @um [Optional]

| | | pictureUse 0-1 (N\*)

| | | pictureQualifier 0-1 (N\*)

| | **attachment 1-1** (N)

| @uid [Optional]  
 | | fileName 0-1 (N)  
 | | @numberingOrg [Optional] (a)  
 | | binaryObject 0-1 (N)  
 | | @format [Optional] (Na)  
 | | @mime [Optional] (Na)  
 | | @encoding [Optional] (Na)  
 | | @characterSet [Optional] (Na)  
 | | **externalReference 0-99** (N)  
 | | | uri 1-1 (N)  
 | | | @isURL [Optional] [Default= true] (Na)  
 | | | mimeTypeCode 0-1 (N)  
 | | | formatCode 0-1 (N)  
 | | | encodingCode 0-1 (N)  
 | | | characterSetCode 0-1 (N)  
 | | note 0-99  
 | | | @numberingOrg [Optional]  
 | | | @codeList [Optional]  
 | | | @noteLabel [Optional]  
 | brand 0-1 (N)  
 | | @numberingOrg [Optional] (a)  
 | | @codeList [Optional] (a)  
 | | @listName [Optional] (a)  
 | | @listVersion [Optional] (a)  
 | | productLine 0-1 (N)  
 | | | @numberingOrg [Optional] (a)  
 | | | @codeList [Optional] (a)  
 | | | @listName [Optional] (a)  
 | | | @listVersion [Optional] (a)  
 | | prodServName 0-1 (U)  
 | | operationalCode 0-19 (N)  
 | | | @numberingOrg [Optional] (a)  
 | | | @codeList [Optional] (a)  
 | | | @listName [Optional] (a)  
 | | | @listVersion [Optional] (a)  
 | | | @codeQualifier [Optional] (Na)  
 | | **garmentCategory 0-1** (P)  
 | | | @numberingOrg [Optional]  
 | | | | artGroup 0-1 (p)  
 | | | | | @numberingOrg [Optional]  
 | | | | | @codeList [Optional]  
 | | | | | @listName [Optional]  
 | | | | | @listVersion [Optional]  
 | | | | artSubGroup 0-1 (p)  
 | | | | | @numberingOrg [Optional]  
 | | | | | @codeList [Optional]  
 | | | | | @listName [Optional]  
 | | | | | @listVersion [Optional]  
 | | | artSex 0-1 (p)  
 | | | | @numberingOrg [Optional]  
 | | | | @codeList [Optional]  
 | | | | @listName [Optional]  
 | | | | @listVersion [Optional]  
 | | | season 0-1 (A)  
 | | | | @numberingOrg [Optional]  
 | | | | @codeList [Optional]  
 | | | | @listName [Optional]  
 | | | | @listVersion [Optional]  
 | | **goodsClassification 0-9** (N)  
 | | | macroClass 0-1 (N)  
 | | | | @numberingOrg [Optional] (a)

| @codeList [Optional] (a)  
 | @listName [Optional] (a)  
 | @listVersion [Optional] (a)  
 | class 0-1 (N)  
 | @numberingOrg [Optional] (a)  
 | @codeList [Optional] (a)  
 | @listName [Optional] (a)  
 | @listVersion [Optional] (a)  
 | subClass 0-1 (N)  
 | @numberingOrg [Optional] (a)  
 | @codeList [Optional] (a)  
 | @listName [Optional] (a)  
 | @listVersion [Optional] (a)  
 | note 0-99  
 | @numberingOrg [Optional]  
 | @codeList [Optional]  
 | @noteLabel [Optional]

**fashionProd 1-1 (N)**

| additionalComponentCode 0-9 (N)  
 | @numberingOrg [Optional]  
 | @codeList [Optional]  
 | @listName [Optional]  
 | @listVersion [Optional]

- choose -

**yarnCode 1-2 (P)**  
 | @numberingOrg [Optional] [Default= CL]  
 | art 1-1 (U)  
 | @numberingOrg [Optional]  
 | @codeList [Optional]  
 | @listName [Optional]  
 | @listVersion [Optional]  
 | color 0-1  
 | @numberingOrg [Optional]  
 | @codeList [Optional]  
 | @listName [Optional]  
 | @listVersion [Optional]  
 | added 0-9  
 | @numberingOrg [Optional]  
 | @addType [Optional]  
 | description 0-unbounded (AU)  
 | @ln [Optional] (N)

- or -

**texCode 1-2 (P)**  
 | @numberingOrg [Optional]  
 | art 1-1 (U)  
 | @numberingOrg [Optional]  
 | @codeList [Optional]  
 | @listName [Optional]  
 | @listVersion [Optional]  
 | pattern 0-1  
 | @numberingOrg [Optional]  
 | @codeList [Optional]  
 | @listName [Optional]  
 | @listVersion [Optional]  
 | color 0-1  
 | @numberingOrg [Optional]  
 | @codeList [Optional]  
 | @listName [Optional]  
 | @listVersion [Optional]  
 | added 0-9  
 | @numberingOrg [Optional]

| | | | | @addType [Optional]  
| | | | | description 0-unbounded (AU)  
| | | | | @ln [Optional] (N)

- or -

| | | | | **acsCode 1-2 (U)**  
| | | | | @numberingOrg [Optional]  
| | | | | art 1-1 (U)  
| | | | | @numberingOrg [Optional]  
| | | | | @codeList [Optional]  
| | | | | @listName [Optional]  
| | | | | @listVersion [Optional]  
| | | | | pattern 0-1  
| | | | | @numberingOrg [Optional]  
| | | | | @codeList [Optional]  
| | | | | @listName [Optional]  
| | | | | @listVersion [Optional]  
| | | | | color 0-1  
| | | | | @numberingOrg [Optional]  
| | | | | @codeList [Optional]  
| | | | | @listName [Optional]  
| | | | | @listVersion [Optional]  
| | | | | added 0-9  
| | | | | @numberingOrg [Optional]  
| | | | | @addType [Optional]  
| | | | | description 0-unbounded (AU)  
| | | | | @ln [Optional] (N)

- or -

| | | | | **garmentPartCode 1-2 (P)**  
| | | | | @numberingOrg [Optional]  
| | | | | gPart 1-1  
| | | | | mod 1-1  
| | | | | @numberingOrg [Optional]  
| | | | | @codeList [Optional]  
| | | | | @listName [Optional]  
| | | | | @listVersion [Optional]  
| | | | | fabric 0-1  
| | | | | @numberingOrg [Optional]  
| | | | | @codeList [Optional]  
| | | | | @listName [Optional]  
| | | | | @listVersion [Optional]  
| | | | | color 0-1  
| | | | | @numberingOrg [Optional]  
| | | | | @codeList [Optional]  
| | | | | @listName [Optional]  
| | | | | @listVersion [Optional]  
| | | | | added 0-19  
| | | | | @numberingOrg [Optional]  
| | | | | @addType [Optional]  
| | | | | size 0-1 (A)  
| | | | | @numberingOrg [Optional] (a)  
| | | | | @codeList [Optional]  
| | | | | @listName [Optional] (a)  
| | | | | @listVersion [Optional] (a)  
| | | | | description 0-unbounded (AU)  
| | | | | @ln [Optional] (N)

- or -

| | | | | **garmentCode 1-2**  
| | | | | @numberingOrg [Optional]

- choose -

| | | | | **garmentCodeB 1-1 (P)**  
| | | | | @numberingOrg [Optional]

					mod 1-1
					@numberingOrg [Optional]
					@codeList [Optional]
					@listName [Optional]
					@listVersion [Optional]
					fabric 0-1
					@numberingOrg [Optional]
					@codeList [Optional]
					@listName [Optional]
					@listVersion [Optional]
					color 0-1
					@numberingOrg [Optional]
					@codeList [Optional]
					@listName [Optional]
					@listVersion [Optional]
					<b>garmentVariant 0-9 (N)</b>
					variantType 1-1 (N)
					@numberingOrg [Optional] (a)
					@codeList [Optional] (a)
					@listName [Optional] (a)
					@listVersion [Optional] (a)
					variantCode 1-1 (N)
					@numberingOrg [Optional] (a)
					@codeList [Optional] (a)
					@listName [Optional] (a)
					@listVersion [Optional] (a)
					drop 0-1 (A)
					@numberingOrg [Optional] (a)
					@codeList [Optional]
					@listName [Optional] (a)
					@listVersion [Optional] (a)
					size 0-1 (A)
					@numberingOrg [Optional] (a)
					@codeList [Optional]
					@listName [Optional] (a)
					@listVersion [Optional] (a)
					artGroup 0-1
					@numberingOrg [Optional]
					@codeList [Optional]
					@listName [Optional]
					@listVersion [Optional]
					added 0-9
					@numberingOrg [Optional]
					@addType [Optional]
					description 0-unbounded (AU)
					@ln [Optional] (N)
				- or -	
					<b>garmentCodeA 1-1 (P)</b>
					art 1-1 (U)
					@numberingOrg [Optional]
					@codeList [Optional]
					@listName [Optional]
					@listVersion [Optional]
					description 0-unbounded (AU)
					@ln [Optional] (N)
				- end choose -	
				- end choose -	
					<b>csRange 0-unbounded (P)</b>
					@numberingOrg [Optional]
					@sizeSystemNat [Optional]
					@sizeSystemSeg [Optional]



```

| @sizeSystemBase [Optional]
| @sizeSystemID [Optional]
| color 0-1
| @numberingOrg [Optional]
| @codeList [Optional]
| @listName [Optional]
| @listVersion [Optional]
| garmentVariant 0-9 (N)
| | variantType 1-1 (N)
| | | @numberingOrg [Optional] (a)
| | | @codeList [Optional] (a)
| | | @listName [Optional] (a)
| | | @listVersion [Optional] (a)
| | variantCode 1-1 (N)
| | | @numberingOrg [Optional] (a)
| | | @codeList [Optional] (a)
| | | @listName [Optional] (a)
| | | @listVersion [Optional] (a)
| drop 0-1 (A)
| | @numberingOrg [Optional] (a)
| | @codeList [Optional]
| | @listName [Optional] (a)
| | @listVersion [Optional] (a)
| sizeMatrix 1-1
| | sizeRow 1-99 (P)
| | | additionalComponentCode 0-9 (N)
| | | | @numberingOrg [Optional] (a)
| | | | @codeList [Optional] (a)
| | | | @listName [Optional] (a)
| | | | @listVersion [Optional] (a)
| | | drop 0-1 (A)
| | | | @numberingOrg [Optional] (a)
| | | | @codeList [Optional]
| | | | @listName [Optional] (a)
| | | | @listVersion [Optional] (a)
| | | size 1-1 (A)
| | | | @numberingOrg [Optional] (a)
| | | | @codeList [Optional]
| | | | @listName [Optional] (a)
| | | | @listVersion [Optional] (a)
| | | qty 0-1
| | | | @um [Required]
| | | itemsList 0-1 (N)
| | | | qualityLevel 0-1 (N)
| | | | | @numberingOrg [Optional] (a)
| | | | | @codeList [Optional] (a)
| | | | | @listName [Optional] (a)
| | | | | @listVersion [Optional] (a)
| | | itemIdentification 1-unbounded (N)
| | | | serialN 1-9 (AU)
| | | | | @numberingOrg [Optional]
| | | | | @idQualifier [Optional] (N)
| note 0-unbounded
| | @numberingOrg [Optional]
| | @codeList [Optional]
| | @noteLabel [Optional]
| composition 0-1 (N)
| | garmentCompos 0-1 (N)
| | | percCompos 1-99
| | | | @fibre [Required]
| description 0-unbounded (AU)

```

```

| | | | | @In [Optional] (N)
| | | | | unitOfMeasure 0-99 (N)
| | | | | @numberingOrg [Optional] [Default= EB] (a)
| | | | | @codeList [Optional] [Default= http://www.ebiz.enea.it/moda-
ml/repository/codelist/v2013-1/gc_NT7.xml] (a)
| | | | | @listName [Optional] [Default= NT7] (a)
| | | | | @listVersion [Optional] (a)
| | | | | @measureQualifier [Optional] (Na)
| | | | | measureConversion 0-99 (N)
| | | | | | unitOfSourceMeasure 1-1 (N)
| | | | | | @numberingOrg [Optional] [Default= EB]
| | | | | | @codeList [Optional] [Default= http://www.ebiz.enea.it/moda-
ml/repository/codelist/v2013-1/gc_NT7.xml]
| | | | | | @listName [Optional] [Default= NT7]
| | | | | | @listVersion [Optional]
| | | | | | @measureQualifier [Optional] (N)
| | | | | | unitOfTargetMeasure 1-1 (N)
| | | | | | @numberingOrg [Optional] [Default= EB]
| | | | | | @codeList [Optional] [Default= http://www.ebiz.enea.it/moda-
ml/repository/codelist/v2013-1/gc_NT7.xml]
| | | | | | @listName [Optional] [Default= NT7]
| | | | | | @listVersion [Optional]
| | | | | | @measureQualifier [Optional] (N)
| | | | | | conversionRate 1-1 (N)
| | | | | | productDim 0-1 (N)
| | | | | | | length 1-1 (p)
| | | | | | | @um [Required]
| | | | | | | width 0-1 (p)
| | | | | | | @um [Required]
| | | | | | | height 0-1 (p)
| | | | | | | @um [Required]
| | | | | | packages 0-1 (P)
| | | | | | @packageLevel [Optional]
| | | | | | - choose -
| | | | | | | packageText 1-1 (U)
| | | | | | | - or -
| | | | | | | package 1-1
| | | | | | | - end choose -
| | | | | | | packageModelCode 0-1 (N)
| | | | | | | @numberingOrg [Optional]
| | | | | | | description 0-unbounded (AU)
| | | | | | | @In [Optional] (N)
| | | | | | | packageDim 0-1
| | | | | | | | length 1-1
| | | | | | | | @um [Required]
| | | | | | | | width 0-1
| | | | | | | | @um [Required]
| | | | | | | | height 0-1
| | | | | | | | @um [Required]
| | | | | | | handlingChar 0-1 (N)
| | | | | | | - choose -
| | | | | | | yarnPack 0-1
| | | | | | | | yarnReel 1-1
| | | | | | | | | @reelType [Required]
| | | | | | | | | @reelMat [Optional]
| | | | | | | | | | yarnReelD 0-1
| | | | | | | | | | @um [Required]
| | | | | | | | | | yarnReelH 0-1
| | | | | | | | | | @um [Required]
| | | | | | | | | | yarnConeAngle 0-1
| | | | | | | | | | yarnReelQty 0-2

```

```

| | | | | | | | @um [Required]
| | | | | | | | label 0-1
| | | | | | | | labelWrit 0-1
| | | | | | | | yarnInWrap 0-1
| | | | | | | | yarnReelWrap 1-1
| | | | | | | | label 0-1
| | | | | | | | labelWrit 0-1
| | | | | | | | - choose -
| | | | | | | | yarnOutWrapText 0-1 (U)
| | | | | | | | - or -
| | | | | | | | yarnOutWrap 0-1
| | | | | | | | - end choose -
- or -
| | | | | | | | piecePack 0-1
| | | | | | | | - choose -
| | | | | | | | piecePackText 1-1 (U)
| | | | | | | | - or -
| | | | | | | | pieceInnWrap1 1-1
| | | | | | | | pieceInnWrap2 0-1
| | | | | | | | pieceOutWrap 0-1
| | | | | | | | - end choose -
- or -
| | | | | | | | acsPack 0-1 (U)
| | | | | | | | - choose -
| | | | | | | | acsPackCode 1-1 (AU)
| | | | | | | | @numberingOrg [Optional] (a)
| | | | | | | | @codeList [Optional] (a)
| | | | | | | | @listName [Optional] (a)
| | | | | | | | @listVersion [Optional] (a)
| | | | | | | | - or -
| | | | | | | | acsPackText 1-1 (U)
| | | | | | | | - end choose -
- or -
| | | | | | | | garPack 0-1 (N)
| | | | | | | | - choose -
| | | | | | | | garPackCode 1-1 (N)
| | | | | | | | @numberingOrg [Optional] (a)
| | | | | | | | @codeList [Optional] (a)
| | | | | | | | @listName [Optional] (a)
| | | | | | | | @listVersion [Optional] (a)
| | | | | | | | - or -
| | | | | | | | garPackText 1-1 (N)
| | | | | | | | - end choose -
- end choose -
| | | | | | | | sortableIndicator 0-1 (N)
| | | | | | | | stackabilityLevel 0-1 (N)
| | | | | | | | handlingType 0-1 (N)
| | | | | | | | @ln [Optional] (Na)
| | | | | | | | volume 0-1
| | | | | | | | @um [Required]
| | | | | | | | netWeight 0-1
| | | | | | | | @um [Required]
| | | | | | | | grossWeight 0-1
| | | | | | | | @um [Required]
| | | | | | | | note 0-99
| | | | | | | | @numberingOrg [Optional]
| | | | | | | | @codeList [Optional]
| | | | | | | | @noteLabel [Optional]
| | | | | | | | itemsPerPackage 0-1 (N)
| | | | | | | | @um [Required]
| | | | | | | | minItemsPerPackage 0-1 (N)

```

```

| | | | @um [Required]
| | | | fillingCriterion 0-9 (N)
| | | | @progr [Optional] (N)
| | | | packageQty 0-1
| | | | packageN 0-unbounded (U)
| | | | @numberingOrg [Optional]
| | | | @packageContainerN [Optional]
| | | | EPClist 0-1
| | | | | EPC 1-unbounded
| | | | | @numberingOrg [Optional]
| | | | | @TID [Optional]
| | | | extendedDescription 0-unbounded (N)
| | | | @ln [Optional] (Na)
| | | | marketPrice 0-unbounded (N)
| | | | | catalogPrice 1-1 (A)
| | | | | @um [Required]
| | | | | @minQty [Optional]
| | | | | @currency [Optional]
| | | | | @garmentMarket [Optional]
| | | | | @maxQty [Optional] (N)
| | | | | allowanceCharge 0-9 (A)
| | | | | | @um [Optional]
| | | | | | @VAT [Optional]
| | | | | | @minQty [Optional]
| | | | | | @currency [Optional]
| | | | | | @maxQty [Optional] (N)
| | | | | | @isCharge [Optional] (N)
| | | | - choose -
| | | | | | AC_category 1-1
| | | | - or -
| | | | | | AC_categoryText 1-1 (U)
| | | | - end choose -
| | | | - choose -
| | | | | | AC_percent 1-1
| | | | - or -
| | | | | | AC_amount 1-1 (A)
| | | | | | @currency [Optional] (a)
| | | | - end choose -
| | | | | | dtScheme 0-1 (P)
| | | | | | @taxType [Required]
| | | | | | | taxCategory 0-1
| | | | | | | taxRate 0-1
| | | | | | | legalRef 0-1 (A)
| | | | | | | @numberingOrg [Optional] (a)
| | | | | | | @codeList [Optional] (a)
| | | | | | | @listName [Optional] (a)
| | | | | | | @listVersion [Optional] (a)
| | | | | | | note 0-99
| | | | | | | @numberingOrg [Optional]
| | | | | | | @codeList [Optional]
| | | | | | | @noteLabel [Optional]
| | | | | geographicArea 0-9 (N)
| | | | - choose -
| | | | | | geographicAreaCode 1-1 (N)
| | | | - or -
| | | | | | geographicAreaText 1-1 (N)
| | | | - end choose -
| | | | | allowanceCharge 0-9 (A)
| | | | | @um [Optional] (a)
| | | | | @VAT [Optional]
| | | | | @minQty [Optional] (a)

```

```

| | | | @currency [Optional] (a)
| | | | @maxQty [Optional] (N)
| | | | @isCharge [Optional] (N)
- choose -
| | | | | AC_category 1-1
- or -
| | | | | AC_categoryText 1-1 (U)
- end choose -
- choose -
| | | | | AC_percent 1-1
- or -
| | | | | AC_amount 1-1 (A)
| | | | | @currency [Optional]
- end choose -
| | | | | dtScheme 0-1 (P)
| | | | | @taxType [Required]
| | | | | taxCategory 0-1
| | | | | taxRate 0-1
| | | | | legalRef 0-1 (A)
| | | | | @numberingOrg [Optional] (a)
| | | | | @codeList [Optional] (a)
| | | | | @listName [Optional] (a)
| | | | | @listVersion [Optional] (a)
| | | | | note 0-99
| | | | | @numberingOrg [Optional]
| | | | | @codeList [Optional]
| | | | | @noteLabel [Optional]
| | | | | garComInfo 0-1 (N*)
| | | | | @endUse [Optional] (a)
| | | | | season 0-1 (A)
| | | | | @numberingOrg [Optional] (a)
| | | | | @codeList [Optional] (a)
| | | | | @listName [Optional] (a)
| | | | | @listVersion [Optional] (a)
| | | | | brand 0-1 (N)
| | | | | @numberingOrg [Optional] (a)
| | | | | @codeList [Optional] (a)
| | | | | @listName [Optional] (a)
| | | | | @listVersion [Optional] (a)
| | | | | productLine 0-1 (N)
| | | | | @numberingOrg [Optional]
| | | | | @codeList [Optional]
| | | | | @listName [Optional]
| | | | | @listVersion [Optional]
| | | | | project 0-1 (U)
| | | | | operationalCode 0-19 (N)
| | | | | @numberingOrg [Optional]
| | | | | @codeList [Optional]
| | | | | @listName [Optional]
| | | | | @listVersion [Optional]
| | | | | @codeQualifier [Optional] (N)
| | | | | deliveryDate 0-1 (p)
| | | | | @dateForm [Optional]
| | | | | specDate 0-1 (p)
| | | | | @dateForm [Optional]
- choose -
| | | | | yarnPack 0-1 (p)
| | | | | | yarnReel 1-1
| | | | | | @reelType [Required]
| | | | | | @reelMat [Optional]
| | | | | | | yarnReelID 0-1

```

```

| | | | | @um [Required]
| | | | | yarnReelH 0-1
| | | | | @um [Required]
| | | | | yarnConeAngle 0-1
| | | | | yarnReelQty 0-2
| | | | | @um [Required]
| | | | | label 0-1
| | | | | labelWrit 0-1
| | | | | yarnInWrap 0-1
| | | | | | yarnReelWrap 1-1
| | | | | | label 0-1
| | | | | | labelWrit 0-1
| | | | | - choose -
| | | | | | yarnOutWrapText 0-1 (U)
| | | | | - or -
| | | | | | yarnOutWrap 0-1
| | | | | - end choose -
| | | | | - or -
| | | | | | piecePack 0-1 (p)
| | | | | - choose -
| | | | | | piecePackText 1-1 (U)
| | | | | - or -
| | | | | | pieceInnWrap1 1-1
| | | | | | pieceInnWrap2 0-1
| | | | | | pieceOutWrap 0-1
| | | | | - end choose -
| | | | | - or -
| | | | | | acsPack 0-1 (U)
| | | | | - choose -
| | | | | | acsPackCode 1-1 (AU)
| | | | | | @numberingOrg [Optional] (a)
| | | | | | @codeList [Optional] (a)
| | | | | | @listName [Optional] (a)
| | | | | | @listVersion [Optional] (a)
| | | | | - or -
| | | | | | acsPackText 1-1 (U)
| | | | | - end choose -
| | | | | - or -
| | | | | | garPack 0-1 (N)
| | | | | - choose -
| | | | | | garPackCode 1-1 (N)
| | | | | | @numberingOrg [Optional] (a)
| | | | | | @codeList [Optional] (a)
| | | | | | @listName [Optional] (a)
| | | | | | @listVersion [Optional] (a)
| | | | | - or -
| | | | | | garPackText 1-1 (N)
| | | | | - end choose -
| | | | | - end choose -
| | | | | | note 0-99
| | | | | | @numberingOrg [Optional]
| | | | | | @codeList [Optional]
| | | | | | @noteLabel [Optional]
| | | | | | dtScheme 0-1 (P)
| | | | | | @taxType [Required]
| | | | | | taxCategory 0-1
| | | | | | taxRate 0-1
| | | | | | legalRef 0-1 (A)
| | | | | | @numberingOrg [Optional] (a)
| | | | | | @codeList [Optional] (a)
| | | | | | @listName [Optional] (a)

```

					<i>@listVersion [Optional]</i> (a)
					note 0-99
					<i>@numberingOrg [Optional]</i>
					<i>@codeList [Optional]</i>
					<i>@noteLabel [Optional]</i>
					note 0-99
					<i>@numberingOrg [Optional]</i>
					<i>@codeList [Optional]</i>
					<i>@noteLabel [Optional]</i>
					note 0-99
					<i>@numberingOrg [Optional]</i>
					<i>@codeList [Optional]</i>
					<i>@noteLabel [Optional]</i>

## 2.2 Detailed description of document elements

Following tables show all elements (complex and simple) used in this document. Description includes: 1) element's information: xml tag, name, brief description, data type and syntax constraints; 2) information about use of the element in a particular position in the document: xpath and possible associated notes.

### 2.2.1 Complex elements (Aggregate Business Information Entities)

Complex elements are those elements whose content is composed of other elements (childs).Complex elements are alphabetically ordered.

<b>acsCode</b>	full codification identifying an accessory product usually coupled with garment or other fashion product (XPath FASCatalog/FCbody/FCgroup/FCitem/fashionProd/acsCode) 1-2 (U) - note: <i>this element can have two instances only if the numbering organisations are different</i>
<b>acsPack</b>	type of wrapping or packing of the accessory (XPath FASCatalog/FCbody/FCgroup/FCitem/garComInfo/acsPack) 0-1 (U) (XPath FASCatalog/FCbody/FCgroup/garComInfo/acsPack) 0-1 (U) (XPath FASCatalog/garComInfo/acsPack) 0-1 (U) (XPath FASCatalog/FCbody/FCgroup/FCitem/packages/handlingChar/acsPack) 0-1 (U)
<b>allowanceCharge</b>	Allowances and Charges related to an Order or a contract (XPath FASCatalog/terms/allowanceCharge) 0-9 (A) (XPath FASCatalog/FCbody/FCgroup/FCitem/allowanceCharge) 0-9 (A) - note: <i>Charges and allowances to be applied to all prices indicated for this item</i> (XPath FASCatalog/FCbody/FCgroup/allowanceCharge) 0-9 (A) - note: <i>It declares conditions applicable to all the group</i> (XPath FASCatalog/FCbody/FCgroup/FCitem/marketPrice/allowanceCharge) 0-9 (A) - note: <i>Allowances and charges to be applied to the price</i>
<b>attachment</b>	an attached document. An attachment can refer to an external document or be included with the document being exchanged (XPath FASCatalog/FCbody/FCgroup/FCitem/refDoc/attachment) 0-1 (N) (XPath FASCatalog/FCheader/picture/attachment) 1-1 (N) (XPath FASCatalog/FCheader/refDoc/attachment) 0-1 (N) (XPath FASCatalog/FCbody/FCgroup/FCitem/picture/attachment) 1-1 (N) (XPath FASCatalog/FCbody/FCgroup/refDoc/attachment) 0-1 (N) (XPath FASCatalog/FCbody/FCgroup/picture/attachment) 1-1 (N)
<b>buyer</b>	details of the Buyer (party that buys the good or service that is object of the current collaborative process) - base type: Nad, (XPath FASCatalog/FCheader/buyer) 0-1 (APp)
<b>composition</b>	Composition of a garment product or of a part of it (XPath FASCatalog/FCbody/FCgroup/FCitem/composition) 0-1 (N)
<b>csRange</b>	range of color-size for a fashion article (XPath FASCatalog/FCbody/FCgroup/FCitem/fashionProd/csRange) 0-unbounded (P)
<b>dtScheme</b>	set of data usable to declare the duty or tax applied (XPath FASCatalog/FCbody/FCgroup/FCitem/marketPrice/allowanceCharge/dtScheme) 0-1 (P) (XPath FASCatalog/terms/allowanceCharge/dtScheme) 0-1 (P) (XPath FASCatalog/FCbody/FCgroup/allowanceCharge/dtScheme) 0-1 (P) (XPath FASCatalog/FCbody/FCgroup/FCitem/allowanceCharge/dtScheme) 0-1 (P) (XPath FASCatalog/FCbody/FCgroup/FCitem/dtScheme) 0-1 (P)



<b>EPCList</b>	list of identifiers used for tracing a physical item with RFID technology (XPath FASCatalog/FCbody/FCgroup/FCitem/packages/EPCList) 0-1 - note: <i>this element is DEPRECATED, please use the specific elements</i>
<b>externalReference</b>	details about an external object, such as a document stored at a remote location (XPath FASCatalog/FCheader/refDoc/attachment/externalReference) 0-99 (N) (XPath FASCatalog/FCbody/FCgroup/picture/attachment/externalReference) 0-99 (N) (XPath FASCatalog/FCbody/FCgroup/FCitem/refDoc/attachment/externalReference) 0-99 (N) (XPath FASCatalog/FCheader/picture/attachment/externalReference) 0-99 (N) (XPath FASCatalog/FCbody/FCgroup/refDoc/attachment/externalReference) 0-99 (N) (XPath FASCatalog/FCbody/FCgroup/FCitem/picture/attachment/externalReference) 0-99 (N)
<b>fashionProd</b>	identification of the fashion product or its part (fabric, yarn, accessory, final product or part of it, ...). (XPath FASCatalog/FCbody/FCgroup/FCitem/fashionProd) 1-1 (N) - note: <i>the csRange element in fashionProd inside FC Item should only be used to indicate which sizes and colors are available, not the quantities.</i>
<b>FCbody</b>	body of the document FASHION CATALOGUE (XPath FASCatalog/FCbody) 1-1 (N*)
<b>FCgroup</b>	Articles grouping of fashion products or their parts for catalogue. (XPath FASCatalog/FCbody/FCgroup) 1-unbounded (N)
<b>FCheader</b>	header of the document FASHION CATALOGUE (XPath FASCatalog/FCheader) 1-1 (N*)
<b>FCitem</b>	Details of a fashion product or component (i.e. fabric, yarn, accessory) for fashion catalogue (XPath FASCatalog/FCbody/FCgroup/FCitem) 0-unbounded (N) - note: <i>More articles in the same group o products</i>
<b>garComInfo</b>	miscellaneous commercial information. (XPath FASCatalog/garComInfo) 0-1 (N*) (XPath FASCatalog/FCbody/FCgroup/FCitem/garComInfo) 0-1 (N*) (XPath FASCatalog/FCbody/FCgroup/garComInfo) 0-1 (N*) - note: <i>It declares conditions applicable to all the group</i>
<b>garmentCategory</b>	classification of a garment article (XPath FASCatalog/FCbody/FCgroup/FCitem/garmentCategory) 0-1 (P)
<b>garmentCode</b>	codification of the garment product (XPath FASCatalog/FCbody/FCgroup/FCitem/fashionProd/garmentCode) 1-2 - note: <i>this element can have two instances only if the numbering organisations are different</i>
<b>garmentCodeA</b>	codification of the garment product- type A (XPath FASCatalog/FCbody/FCgroup/FCitem/fashionProd/garmentCode/garmentCodeA) 1-1 (P) - note: <i>here the barcode EAN-13 or EAN-8 should be specified</i>
<b>garmentCodeB</b>	codification of the garment product - type B (XPath FASCatalog/FCbody/FCgroup/FCitem/fashionProd/garmentCode/garmentCodeB) 1-1 (P)
<b>garmentCompos</b>	Quantitative composition of a garment product (of its part) (XPath FASCatalog/FCbody/FCgroup/FCitem/composition/garmentCompos) 0-1 (N)
<b>garmentPartCode</b>	codification of the component or part of a fashion article (XPath FASCatalog/FCbody/FCgroup/FCitem/fashionProd/garmentPartCode) 1-2 (P)

	- note: <i>this element can have two instances only if the numbering organisations are different</i>
<b>garmentVariant</b>	garment product variant (XPath FASCatalog/FCbody/FCgroup/FCitem/fashionProd/garmentCode/garmentCodeB/garmentVariant) 0-9 (N) (XPath FASCatalog/FCbody/FCgroup/FCitem/fashionProd/csRange/garmentVariant) 0-9 (N) - note: <i>used only if not already specified in the article code</i>
<b>garPack</b>	the packaging mode of the item or a part of it. (XPath FASCatalog/FCbody/FCgroup/garComInfo/garPack) 0-1 (N) (XPath FASCatalog/FCbody/FCgroup/FCitem/garComInfo/garPack) 0-1 (N) (XPath FASCatalog/garComInfo/garPack) 0-1 (N) (XPath FASCatalog/FCbody/FCgroup/FCitem/packages/handlingChar/garPack) 0-1 (N)
<b>geographicArea</b>	identification of a geographic area - base type: string, (XPath FASCatalog/FCbody/FCgroup/FCitem/marketPrice/geographicArea) 0-9 (N) - note: <i>geographical area to which the indicated price applies (one or more)</i>
<b>goodsClassification</b>	goods classification of the item. (XPath FASCatalog/FCbody/FCgroup/FCitem/garmentCategory/goodsClassification) 0-9 (N)
<b>handlingChar</b>	features of an item (item or package) useful for its transport and warehouse management. (XPath FASCatalog/FCbody/FCgroup/FCitem/packages/handlingChar) 0-1 (N) - note: <i>in this case the characteristics are related to the package.</i>
<b>insPayment</b>	payment details for payment by installments (XPath FASCatalog/terms/insPayment) 0-5 - note: <i>excluded the case of offers, this set of data is alternative to payment set and must be iterated for each payment installment</i>
<b>itemIdentification</b>	serial identification of a product unit (XPath FASCatalog/FCbody/FCgroup/FCitem/fashionProd/csRange/sizeMatrix/sizeRow/itemsList/itemIdentification) 1-unbounded (N) - note: <i>identification of the single product unit contained in the list</i>
<b>itemsList</b>	list of the single product units (XPath FASCatalog/FCbody/FCgroup/FCitem/fashionProd/csRange/sizeMatrix/sizeRow/itemsList) 0-1 (N) - note: <i>the usage in this position is alternative to its usage within the document line element</i>
<b>marketPrice</b>	price shown for a specific market catalogue (XPath FASCatalog/FCbody/FCgroup/FCitem/marketPrice) 0-unbounded (N)
<b>measureConversion</b>	Details to convert two different unit of measure. (XPath FASCatalog/FCbody/FCgroup/FCitem/measureConversion) 0-99 (N)
<b>packageDim</b>	dimensions of a transport package (XPath FASCatalog/FCbody/FCgroup/FCitem/packages/packageDim) 0-1
<b>packages</b>	describes the composition of the transport packaging. Each element corresponds to a type of package: type, quantity, hierarchic level, list of identifiers of the single packages (XPath FASCatalog/FCbody/FCgroup/FCitem/packages) 0-1 (P) - note: <i>Use to indicate the packaging of the product</i>
<b>payment</b>	payment details for payment all in one (XPath FASCatalog/terms/payment) 0-5 - note: <i>excluded the case of offers, this set of data is alternative to insPayment, it can be iterated to specify alternative terms of payment (e.g.: 60 days or 30 days with 3% discount)</i>

<b>picture</b>	<p>picture; image features and its representation or link to it</p> <ul style="list-style-type: none"> <li>- base type: ,</li> <li>(XPath FASCatalog/FCheader/picture) 0-9 (N*)</li> <li>- note: <i>Images associated to the whole catalogue (i.e. cover)</i></li> <li>(XPath FASCatalog/FCbody/FCgroup/picture) 0-99 (N*)</li> <li>- note: <i>Images associated to the whole group</i></li> <li>(XPath FASCatalog/FCbody/FCgroup/FCitem/picture) 0-99 (N*)</li> </ul>
<b>piecePack</b>	<p>type of wrapping or packing of the fabric pieces</p> <ul style="list-style-type: none"> <li>(XPath FASCatalog/garComInfo/piecePack) 0-1 (p)</li> <li>(XPath FASCatalog/FCbody/FCgroup/FCitem/garComInfo/piecePack) 0-1 (p)</li> <li>(XPath FASCatalog/FCbody/FCgroup/FCitem/packages/handlingChar/piecePack) 0-1</li> <li>(XPath FASCatalog/FCbody/FCgroup/garComInfo/piecePack) 0-1 (p)</li> </ul>
<b>productDim</b>	<p>Dimensions of an object.</p> <ul style="list-style-type: none"> <li>(XPath FASCatalog/FCbody/FCgroup/FCitem/productDim) 0-1 (N)</li> <li>- note: <i>Dimension of the article</i></li> </ul>
<b>refDoc</b>	<p>identification of a document and of an item thereof, to which the message makes reference</p> <ul style="list-style-type: none"> <li>(XPath FASCatalog/FCheader/refDoc) 0-9 (P)</li> <li>(XPath FASCatalog/FCbody/FCgroup/FCitem/refDoc) 0-9 (P)</li> <li>(XPath FASCatalog/FCbody/FCgroup/refDoc) 0-9 (P)</li> </ul>
<b>sizeMatrix</b>	<p>size matrix of an apparel product</p> <ul style="list-style-type: none"> <li>(XPath FASCatalog/FCbody/FCgroup/FCitem/fashionProd/csRange/sizeMatrix) 1-1</li> </ul>
<b>sizeRow</b>	<p>size matrix row of an apparel product</p> <ul style="list-style-type: none"> <li>(XPath FASCatalog/FCbody/FCgroup/FCitem/fashionProd/csRange/sizeMatrix/sizeRow) 1-99 (P)</li> </ul>
<b>supplier</b>	<p>details of the Supplier (party that supplies the good or service that is object of the current collaborative process)</p> <ul style="list-style-type: none"> <li>- base type: Nad,</li> <li>(XPath FASCatalog/FCheader/supplier) 1-1 (APp)</li> </ul>
<b>terms</b>	<p>details of the commercial obligations for payment and delivery</p> <ul style="list-style-type: none"> <li>(XPath FASCatalog/terms) 0-1 (P)</li> </ul>
<b>texCode</b>	<p>full codification of the textile product</p> <ul style="list-style-type: none"> <li>(XPath FASCatalog/FCbody/FCgroup/FCitem/fashionProd/texCode) 1-2 (P)</li> <li>- note: <i>this element can have two instances only if the numbering organisations are different</i></li> </ul>
<b>thirdParty</b>	<p>details of the Third Party, different from Sender and Receiver of the document</p> <ul style="list-style-type: none"> <li>- base type: Nad,</li> <li>(XPath FASCatalog/FCheader/thirdParty) 0-5 (AP)</li> </ul>
<b>trade</b>	<p>general terms of trade for the specified supply</p> <ul style="list-style-type: none"> <li>(XPath FASCatalog/terms/trade) 0-1</li> </ul>
<b>transInfo</b>	<p>details of transport: mode, carrier and delivery place</p> <ul style="list-style-type: none"> <li>(XPath FASCatalog/terms/transInfo) 0-5 (pAP)</li> </ul>
<b>yarnCode</b>	<p>full codification of a yarn product</p> <ul style="list-style-type: none"> <li>(XPath FASCatalog/FCbody/FCgroup/FCitem/fashionProd/yarnCode) 1-2 (P)</li> <li>- note: <i>this element can have two instances only if the numbering organisations are different</i></li> </ul>
<b>yarnInWrap</b>	<p>details specifying the inner wrapping of a yarn product</p> <ul style="list-style-type: none"> <li>(XPath FASCatalog/garComInfo/yarnPack/yarnInWrap) 0-1</li> <li>(XPath FASCatalog/FCbody/FCgroup/FCitem/garComInfo/yarnPack/yarnInWrap) 0-1</li> <li>(XPath FASCatalog/FCbody/FCgroup/garComInfo/yarnPack/yarnInWrap) 0-1</li> </ul>

	(XPath FASCatalog/FCbody/FCgroup/FCitem/packages/handlingChar/yarnPack/yarnInWrap) 0-1
<b>yarnPack</b>	<p>details of type of presentation used for the yarn</p> <p>(XPath FASCatalog/FCbody/FCgroup/garComInfo/yarnPack) 0-1 (p)</p> <p>(XPath FASCatalog/FCbody/FCgroup/FCitem/garComInfo/yarnPack) 0-1 (p)</p> <p>(XPath FASCatalog/garComInfo/yarnPack) 0-1 (p)</p> <p>(XPath FASCatalog/FCbody/FCgroup/FCitem/packages/handlingChar/yarnPack) 0-1</p>
<b>yarnReel</b>	<p>details of the packaging of a yarn product (bobbin and reel,...)</p> <p>(XPath FASCatalog/FCbody/FCgroup/garComInfo/yarnPack/yarnReel) 1-1</p> <p>(XPath FASCatalog/FCbody/FCgroup/FCitem/packages/handlingChar/yarnPack/yarnReel) 1-1</p> <p>(XPath FASCatalog/garComInfo/yarnPack/yarnReel) 1-1</p> <p>(XPath FASCatalog/FCbody/FCgroup/FCitem/garComInfo/yarnPack/yarnReel) 1-1</p>

## 2.2.2 Simple elements (Basic Business Information Entities)

Simple elements are those elements whose content is characterized by a data type plus a domain of possible values. Simple elements are alphabetically ordered.

<b>AC_amount</b>	<p>amount of an Allowance or Charge</p> <p>- base type: decimal, fraction digits: 2,</p> <p>(XPath FASCatalog/FCbody/FCgroup/FCitem/allowanceCharge/AC_amount) 1-1 (A)</p> <p>(XPath FASCatalog/terms/allowanceCharge/AC_amount) 1-1 (A)</p> <p>(XPath FASCatalog/FCbody/FCgroup/FCitem/marketPrice/allowanceCharge/AC_amount) 1-1 (A)</p> <p>(XPath FASCatalog/FCbody/FCgroup/allowanceCharge/AC_amount) 1-1 (A)</p>
<b>AC_category</b>	<p>coded specification of an Allowance or Charge</p> <p>- base type: string, cod. table: T41</p> <p><a href="http://www.ebiz.enea.it/moda-ml/repository/codelist/v2018-1/gc_T41.xml">http://www.ebiz.enea.it/moda-ml/repository/codelist/v2018-1/gc_T41.xml</a></p> <p>(XPath FASCatalog/FCbody/FCgroup/allowanceCharge/AC_category) 1-1</p> <p>(XPath FASCatalog/FCbody/FCgroup/FCitem/allowanceCharge/AC_category) 1-1</p> <p>(XPath FASCatalog/FCbody/FCgroup/FCitem/marketPrice/allowanceCharge/AC_category) 1-1</p> <p>(XPath FASCatalog/terms/allowanceCharge/AC_category) 1-1</p>
<b>AC_categoryText</b>	<p>free text description of an Allowance or Charge</p> <p>- base type: string, max length: 250,</p> <p>(XPath FASCatalog/terms/allowanceCharge/AC_categoryText) 1-1 (U)</p> <p>(XPath FASCatalog/FCbody/FCgroup/FCitem/allowanceCharge/AC_categoryText) 1-1 (U)</p> <p>(XPath FASCatalog/FCbody/FCgroup/FCitem/marketPrice/allowanceCharge/AC_categoryText) 1-1 (U)</p> <p>(XPath FASCatalog/FCbody/FCgroup/allowanceCharge/AC_categoryText) 1-1 (U)</p>
<b>AC_percent</b>	<p>amount of an Allowance or Charge as a percentage (always non negative value)</p> <p>- base type: decimal, max inclusive: 100, fraction digits: 2,</p> <p>(XPath FASCatalog/FCbody/FCgroup/allowanceCharge/AC_percent) 1-1</p> <p>(XPath FASCatalog/FCbody/FCgroup/FCitem/allowanceCharge/AC_percent) 1-1</p> <p>(XPath FASCatalog/terms/allowanceCharge/AC_percent) 1-1</p> <p>(XPath FASCatalog/FCbody/FCgroup/FCitem/marketPrice/allowanceCharge/AC_percent) 1-1</p>
<b>acsPackCode</b>	<p>code specifying the type of wrapping or packing used for the accessory</p> <p>- base type: string,</p> <p>(XPath FASCatalog/garComInfo/acsPack/acsPackCode) 1-1 (AU)</p> <p>(XPath FASCatalog/FCbody/FCgroup/FCitem/packages/handlingChar/acsPack/acsPackCode) 1-1 (AU)</p> <p>(XPath FASCatalog/FCbody/FCgroup/garComInfo/acsPack/acsPackCode) 1-1 (AU)</p>

	(XPath FASCatalog/FCbody/FCgroup/FCitem/garComInfo/acsPack/acsPackCode) 1-1 (AU)
acsPackText	<p>free text specifying the type of wrapping or packing used for the accessory</p> <p>- base type: string, max length: 250,</p> <p>(XPath FASCatalog/FCbody/FCgroup/FCitem/garComInfo/acsPack/acsPackText) 1-1 (U)</p> <p>(XPath FASCatalog/FCbody/FCgroup/FCitem/packages/handlingChar/acsPack/acsPackText) 1-1 (U)</p> <p>(XPath FASCatalog/FCbody/FCgroup/garComInfo/acsPack/acsPackText) 1-1 (U)</p> <p>(XPath FASCatalog/garComInfo/acsPack/acsPackText) 1-1 (U)</p>
added	<p>additional code of the product (complementing the formers)</p> <p>- base type: string, max length: 80,</p> <p>(XPath FASCatalog/FCbody/FCgroup/FCitem/fashionProd/garmentCode/garmentCodeB/added) 0-9</p> <p>(XPath FASCatalog/FCbody/FCgroup/FCitem/fashionProd/garmentPartCode/added) 0-19</p> <p>(XPath FASCatalog/FCbody/FCgroup/FCitem/fashionProd/acsCode/added) 0-9</p> <p>- note: <i>here an additional codification (see table T44) can be specified</i> (XPath FASCatalog/FCbody/FCgroup/FCitem/fashionProd/texCode/added) 0-9</p> <p>- note: <i>here an additional codification (see table T44) can be specified</i> (XPath FASCatalog/FCbody/FCgroup/FCitem/fashionProd/yarnCode/added) 0-9</p> <p>- note: <i>here an additional codification (see table T44) can be specified</i></p>
additionalComponentCode	<p>an additional code to identify a fashion product or a part of it (it is a way to codify the item, but it is not one of the codes to identify it). It is not a serial identifier.</p> <p>- base type: string,</p> <p>(XPath FASCatalog/FCbody/FCgroup/FCitem/fashionProd/csRange/sizeMatrix/sizeRow/additionalComponentCode) 0-9 (N)</p> <p>(XPath FASCatalog/FCbody/FCgroup/FCitem/fashionProd/additionalComponentCode) 0-9 (N)</p> <p>- note: <i>If the code is related to the size, the (non serial) unique product code should not be here (use the same element within sizeRow).</i></p>
additionalIdentifier	<p>additional identification code of a Party, for example customs registries or others</p> <p>- base type: string, max length: 15,</p> <p>(XPath FASCatalog/FCheader/buyer/additionalIdentifier) 0-9 (N)</p> <p>- note: <i>identifiers for example for exports, such as MID (Manufacturer Identification Code), EORI (E.O.R.I. - Economic Operator Registration and Identification)</i> (XPath FASCatalog/FCheader/supplier/additionalIdentifier) 0-9 (N)</p> <p>- note: <i>identifiers for example for exports, such as MID (Manufacturer Identification Code), EORI (E.O.R.I. - Economic Operator Registration and Identification)</i></p>
@addType	<p>qualifier of the additional coding of a product</p> <p>- base type: string, cod. table: T44 <a href="http://www.ebiz.enea.it/moda-ml/repository/codelist/v2018-1/gc_T44.xml">http://www.ebiz.enea.it/moda-ml/repository/codelist/v2018-1/gc_T44.xml</a></p> <p>(XPath FASCatalog/FCbody/FCgroup/FCitem/fashionProd/acsCode/added/@addType) [Optional]</p> <p>- nota: <i>addType allows the clarification of the meaning of the added element content; it is strongly suggested to use it always.</i> (XPath FASCatalog/FCbody/FCgroup/FCitem/fashionProd/garmentPartCode/added/@addType) [Optional]</p> <p>- nota: <i>addType allows the clarification of the meaning of the added element content; it is strongly suggested to use it always.</i> (XPath FASCatalog/FCbody/FCgroup/FCitem/fashionProd/yarnCode/added/@addType) [Optional]</p> <p>- nota: <i>addType allows the clarification of the meaning of the added element content; it is strongly suggested to use it always.</i></p>

	<p>(XPath FASCatalog/FCbody/FCgroup/FCitem/fashionProd/texCode/added/@addType) [Optional]</p> <p>- nota: <i>addType</i> allows the clarification of the meaning of the added element content; it is strongly suggested to use it always.</p> <p>(XPath FASCatalog/FCbody/FCgroup/FCitem/fashionProd/garmentCode/garmentCodeB/added/@addType) [Optional]</p> <p>- nota: <i>addType</i> allows the clarification of the meaning of the added element content; it is strongly suggested to use it always.</p>
alternativeText	<p>alternative text of the picture</p> <p>- base type: string, max length: 255, (XPath FASCatalog/FCbody/FCgroup/picture/alternativeText) 0-unbounded (N*)</p> <p>- note: Only one instance of this element for each different value of 'In' attribute (language) (XPath FASCatalog/FCheader/picture/alternativeText) 0-unbounded (N*)</p> <p>- note: Only one instance of this element for each different value of 'In' attribute (language) (XPath FASCatalog/FCbody/FCgroup/FCitem/picture/alternativeText) 0-unbounded (N*)</p> <p>- note: Only one instance of this element for each different value of 'In' attribute (language)</p>
art	<p>article number of the product</p> <p>- base type: string, max length: 80, (XPath FASCatalog/FCbody/FCgroup/FCitem/fashionProd/garmentCode/garmentCodeA/art) 1-1 (U)</p> <p>(XPath FASCatalog/FCbody/FCgroup/FCitem/fashionProd/yarnCode/art) 1-1 (U)</p> <p>(XPath FASCatalog/FCbody/FCgroup/FCitem/fashionProd/acsCode/art) 1-1 (U)</p> <p>(XPath FASCatalog/FCbody/FCgroup/FCitem/fashionProd/texCode/art) 1-1 (U)</p> <p>- note: can be used either for the base-article (excluding pattern/colour) or for the SKU</p>
artGroup	<p>code identifying a class of products</p> <p>- base type: string, max length: 40, (XPath FASCatalog/FCbody/FCgroup/FCitem/garmentCategory/artGroup) 0-1 (p)</p> <p>(XPath FASCatalog/FCbody/FCgroup/artGroup) 0-1</p> <p>(XPath FASCatalog/FCbody/FCgroup/FCitem/fashionProd/garmentCode/garmentCodeB/artGroup) 0-1</p>
artGroupName	<p>description of a class of products</p> <p>- base type: string, max length: 80, (XPath FASCatalog/FCbody/FCgroup/artGroupName) 0-1 (U)</p>
artSex	<p>code identifying the sex for which a fashion product is intended</p> <p>- base type: string, max length: 15, (XPath FASCatalog/FCbody/FCgroup/FCitem/garmentCategory/artSex) 0-1 (p)</p>
artSubGroup	<p>code identifying a sub-class of products</p> <p>- base type: string, max length: 40, (XPath FASCatalog/FCbody/FCgroup/FCitem/garmentCategory/artSubGroup) 0-1 (p)</p>
binaryObject	<p>a binary large object containing an attached document, Coding 'base64Binary' is recommended.</p> <p>- base type: base64Binary, (XPath FASCatalog/FCheader/picture/attachment/binaryObject) 0-1 (N)</p> <p>(XPath FASCatalog/FCbody/FCgroup/picture/attachment/binaryObject) 0-1 (N)</p> <p>(XPath FASCatalog/FCbody/FCgroup/FCitem/picture/attachment/binaryObject) 0-1 (N)</p> <p>(XPath FASCatalog/FCheader/refDoc/attachment/binaryObject) 0-1 (N)</p> <p>(XPath FASCatalog/FCbody/FCgroup/refDoc/attachment/binaryObject) 0-1 (N)</p> <p>(XPath FASCatalog/FCbody/FCgroup/FCitem/refDoc/attachment/binaryObject) 0-1 (N)</p>

brand	A brand name. - base type: string, (XPath FASCatalog/FCbody/FCgroup/FCitem/garComInfo/brand) 0-1 (N) (XPath FASCatalog/garComInfo/brand) 0-1 (N) (XPath FASCatalog/FCbody/FCgroup/FCitem/brand) 0-1 (N) (XPath FASCatalog/FCbody/FCgroup/garComInfo/brand) 0-1 (N)
carrier	identification of the transport carrier - base type: string, max length: 40, (XPath FASCatalog/terms/transInfo/carrier) 0-1
catalogPrice	price shown in the Supplier's Catalogue - base type: decimal, fraction digits: 2, (XPath FASCatalog/FCbody/FCgroup/FCitem/marketPrice/catalogPrice) 1-1 (A) - note: <i>Unit price not including allowances and charges</i>
@characterSet	the character set of the binary object (examples UTF-8, UTF-16, Windows-1252, ISO-8859-7,...) - base type: normalizedString, (XPath FASCatalog/FCheader/picture/attachment/binaryObject/@characterSet) [Optional] (Na) (XPath FASCatalog/FCbody/FCgroup/FCitem/refDoc/attachment/binaryObject/@characterSet) [Optional] (Na) (XPath FASCatalog/FCheader/refDoc/attachment/binaryObject/@characterSet) [Optional] (Na) (XPath FASCatalog/FCbody/FCgroup/refDoc/attachment/binaryObject/@characterSet) [Optional] (N) (XPath FASCatalog/FCbody/FCgroup/picture/attachment/binaryObject/@characterSet) [Optional] (N) (XPath FASCatalog/FCbody/FCgroup/FCitem/picture/attachment/binaryObject/@characterSet) [Optional] (Na)
characterSetCode	the character set of an external document (examples UTF-8, UTF-16, Windows-1252, ISO-8859-7,...) - base type: normalizedString, (XPath FASCatalog/FCbody/FCgroup/refDoc/attachment/externalReference/characterSetCode) 0-1 (N) (XPath FASCatalog/FCbody/FCgroup/FCitem/picture/attachment/externalReference/characterSetCode) 0-1 (N) (XPath FASCatalog/FCheader/picture/attachment/externalReference/characterSetCode) 0-1 (N) (XPath FASCatalog/FCbody/FCgroup/picture/attachment/externalReference/characterSetCode) 0-1 (N) (XPath FASCatalog/FCheader/refDoc/attachment/externalReference/characterSetCode) 0-1 (N) (XPath FASCatalog/FCbody/FCgroup/FCitem/refDoc/attachment/externalReference/characterSetCode) 0-1 (N)
city	name of the city (town, village) - base type: string, max length: 40, (XPath FASCatalog/FCheader/buyer/city) 0-1 (XPath FASCatalog/FCheader/supplier/city) 0-1 (XPath FASCatalog/FCheader/thirdParty/city) 0-1
class	a code indicating the category (macro-class, class or sub-class) of a commodity classification system the article belongs to. - base type: string, (XPath FASCatalog/FCbody/FCgroup/FCitem/garmentCategory/goodsClassification/class) 0-1 (N)
@codeList	it specifies the URL where the list of codes used to make an instance of the element can be found - base type: string, max length: 255,

(XPath FASCatalog/FCbody/FCgroup/FCitem/packages/handlingChar/garPack/garPackCode/@codeList) [Optional] (a)

- nota: *at least one out of this attribute and "numberingOrg" should be set*

(XPath FASCatalog/FCbody/FCgroup/garComInfo/operationalCode/@codeList) [Optional] (a)

- nota: *at least one out of this attribute and "numberingOrg" should be set*

(XPath FASCatalog/FCbody/FCgroup/FCitem/packages/handlingChar/note/@codeList) [Optional]

- nota: *must be used to provide (URL) the list of codes used in "noteLabel"*

(XPath FASCatalog/FCbody/FCgroup/garComInfo/acsPack/acsPackCode/@codeList) [Optional]

- nota: *at least one out of this attribute and "numberingOrg" should be set*

(XPath FASCatalog/FCbody/FCgroup/FCitem/measureConversion/unitOfTargetMeasure/@codeList) [Optional] [Default= [http://www.ebiz.enea.it/moda-ml/repository/codelist/v2013-1/gc\\_NT7.xml](http://www.ebiz.enea.it/moda-ml/repository/codelist/v2013-1/gc_NT7.xml)]

- nota: *Codes from tabel NT7 are suggested.*

(XPath FASCatalog/FCbody/FCgroup/FCitem/picture/note/@codeList) [Optional]

- nota: *must be used to provide (URL) the list of codes used in "noteLabel"*

(XPath FASCatalog/FCbody/FCgroup/FCitem/brand/@codeList) [Optional] (a)

- nota: *at least one out of this attribute and "numberingOrg" should be set*

(XPath FASCatalog/FCbody/FCgroup/FCitem/refDoc/season/@codeList) [Optional] (a)

- nota: *this attribute should be used either single or coupled with "listName" and "listVersion"*

(XPath FASCatalog/FCbody/FCgroup/garComInfo/garPack/garPackCode/@codeList) [Optional]

- nota: *at least one out of this attribute and "numberingOrg" should be set*

(XPath FASCatalog/FCbody/FCgroup/garComInfo/note/@codeList) [Optional]

- nota: *must be used to provide (URL) the list of codes used in "noteLabel"*

(XPath FASCatalog/FCbody/FCgroup/FCitem/packages/handlingChar/acsPack/acsPackCode/@codeList) [Optional] (a)

- nota: *at least one out of this attribute and "numberingOrg" should be set*

(XPath FASCatalog/FCbody/FCgroup/FCitem/garComInfo/season/@codeList) [Optional] (a)

- nota: *this attribute should be used either single or coupled with "listName" and "listVersion"*

(XPath FASCatalog/garComInfo/note/@codeList) [Optional]

- nota: *must be used to provide (URL) the list of codes used in "noteLabel"*

(XPath FASCatalog/FCbody/FCgroup/artGroup/@codeList) [Optional]

- nota: *at least one out of this attribute and "numberingOrg" should be set*

(XPath FASCatalog/FCbody/FCgroup/refDoc/season/@codeList) [Optional] (a)

- nota: *this attribute should be used either single or coupled with "listName" and "listVersion"*

(XPath FASCatalog/FCbody/FCgroup/FCitem/allowanceCharge/dtScheme/note/@codeList) [Optional]

- nota: *must be used to provide (URL) the list of codes used in "noteLabel"*

(XPath FASCatalog/FCbody/FCgroup/FCitem/garComInfo/productLine/@codeList) [Optional]

- nota: *at least one out of this attribute and "numberingOrg" should be set*

(XPath FASCatalog/FCbody/FCgroup/FCitem/garComInfo/operationalCode/@codeList) [Optional]

- nota: *at least one out of this attribute and "numberingOrg" should be set*

(XPath FASCatalog/garComInfo/acsPack/acsPackCode/@codeList) [Optional] (a)

- nota: *at least one out of this attribute and "numberingOrg" should be set*

(XPath FASCatalog/garComInfo/garPack/garPackCode/@codeList) [Optional] (a)

- nota: *at least one out of this attribute and "numberingOrg" should be set*

(XPath FASCatalog/FCbody/FCgroup/FCitem/garComInfo/brand/@codeList) [Optional] (a)

- nota: *at least one out of this attribute and "numberingOrg" should be set*

(XPath FASCatalog/FCbody/FCgroup/allowanceCharge/dtScheme/note/@codeList) [Optional]

- nota: *must be used to provide (URL) the list of codes used in "noteLabel"*

(XPath FASCatalog/FCbody/FCgroup/allowanceCharge/dtScheme/legalRef/@codeList) [Optional] (a)



(XPath FASCatalog/FCbody/FCgroup/garComInfo/season/@codeList) [Optional] (a)  
- nota: *this attribute should be used either single or coupled with "listName" and "listVersion"*

(XPath FASCatalog/FCbody/FCgroup/garComInfo/productLine/@codeList) [Optional] (a)  
- nota: *at least one out of this attribute and "numberingOrg" should be set*

(XPath FASCatalog/FCbody/FCgroup/garComInfo/brand/@codeList) [Optional] (a)  
- nota: *at least one out of this attribute and "numberingOrg" should be set*

(XPath FASCatalog/FCheader/refDoc/season/@codeList) [Optional] (a)  
- nota: *this attribute should be used either single or coupled with "listName" and "listVersion"*

(XPath FASCatalog/FCbody/FCgroup/FCitem/allowanceCharge/dtScheme/legalRef/@codeList) [Optional] (a)  
(XPath FASCatalog/FCbody/FCgroup/FCitem/marketPrice/allowanceCharge/dtScheme/note/@codeList) [Optional]  
- nota: *must be used to provide (URL) the list of codes used in "noteLabel"*

(XPath FASCatalog/FCbody/FCgroup/FCitem/marketPrice/allowanceCharge/dtScheme/legalRef/@codeList) [Optional] (a)  
(XPath FASCatalog/FCbody/FCgroup/picture/note/@codeList) [Optional]  
- nota: *must be used to provide (URL) the list of codes used in "noteLabel"*

(XPath FASCatalog/FCbody/FCgroup/FCitem/measureConversion/unitOfSourceMeasure/@codeList) [Optional] [Default= [http://www.ebiz.enea.it/moda-ml/repository/codelist/v2013-1/gc\\_NT7.xml](http://www.ebiz.enea.it/moda-ml/repository/codelist/v2013-1/gc_NT7.xml)]  
- nota: *Codes from tabel NT7 are suggested.*

(XPath FASCatalog/FCbody/FCgroup/FCitem/fashionProd/garmentPartCode/fabric/@codeList) [Optional]  
- nota: *at least one out of this attribute and "numberingOrg" should be set*

(XPath FASCatalog/FCbody/FCgroup/FCitem/fashionProd/garmentPartCode/mod/@codeList) [Optional]  
- nota: *at least one out of this attribute and "numberingOrg" should be set*

(XPath FASCatalog/FCbody/FCgroup/FCitem/fashionProd/garmentPartCode/color/@codeList) [Optional]  
- nota: *this attribute should be used either single or coupled with "listName" and "listVersion"*

(XPath FASCatalog/FCbody/FCgroup/FCitem/fashionProd/garmentPartCode/size/@codeList) [Optional]  
(XPath FASCatalog/FCbody/FCgroup/FCitem/fashionProd/csRange/garmentVariant/variantCode/@codeList) [Optional] (a)  
- nota: *at least one out of this attribute and "numberingOrg" should be set*

(XPath FASCatalog/FCbody/FCgroup/FCitem/fashionProd/csRange/drop/@codeList) [Optional]  
(XPath FASCatalog/FCbody/FCgroup/FCitem/fashionProd/acsCode/art/@codeList) [Optional]  
- nota: *at least one out of this attribute and "numberingOrg" should be set*

(XPath FASCatalog/FCbody/FCgroup/FCitem/fashionProd/texCode/color/@codeList) [Optional]  
- nota: *this attribute should be used either single or coupled with "listName" and "listVersion"*

(XPath FASCatalog/FCbody/FCgroup/FCitem/fashionProd/csRange/sizeMatrix/sizeRow/additionalComponentCode/@codeList) [Optional] (a)  
- nota: *at least one out of this attribute and "numberingOrg" should be set*

(XPath FASCatalog/FCbody/FCgroup/FCitem/fashionProd/acsCode/color/@codeList) [Optional]  
- nota: *this attribute should be used either single or coupled with "listName" and "listVersion"*

(XPath FASCatalog/FCbody/FCgroup/FCitem/fashionProd/acsCode/pattern/@codeList) [Optional]  
- nota: *at least one out of this attribute and "numberingOrg" should be set*

(XPath FASCatalog/FCbody/FCgroup/FCitem/fashionProd/garmentCode/garmentCodeB/drop/@codeList) [Optional]  
(XPath FASCatalog/FCbody/FCgroup/FCitem/fashionProd/garmentCode/garmentCodeB/garmentVariant/variantCode/@codeList) [Optional] (a)  
- nota: *at least one out of this attribute and "numberingOrg" should be set*

(XPath FASCatalog/FCbody/FCgroup/FCitem/fashionProd/garmentCode/garmentCodeB/size/@codeList) [Optional]

(XPath FASCatalog/FCbody/FCgroup/FCitem/fashionProd/garmentCode/garmentCodeB/artGroup/@codeList) [Optional]

- nota: *at least one out of this attribute and "numberingOrg" should be set*

(XPath FASCatalog/FCbody/FCgroup/FCitem/fashionProd/garmentCode/garmentCodeA/art/@codeList) [Optional]

- nota: *at least one out of this attribute and "numberingOrg" should be set*

(XPath FASCatalog/FCbody/FCgroup/FCitem/fashionProd/garmentCode/garmentCodeB/garmentVariant/variantType/@codeList) [Optional] (a)

- nota: *always at least one out of this attribute and "numberingOrg" should be set*

(XPath FASCatalog/FCbody/FCgroup/FCitem/fashionProd/garmentCode/garmentCodeB/mod/@codeList) [Optional]

- nota: *at least one out of this attribute and "numberingOrg" should be set*

(XPath FASCatalog/FCbody/FCgroup/FCitem/fashionProd/csRange/garmentVariant/variantType/@codeList) [Optional] (a)

- nota: *always at least one out of this attribute and "numberingOrg" should be set*

(XPath FASCatalog/FCbody/FCgroup/FCitem/fashionProd/garmentCode/garmentCodeB/fabric/@codeList) [Optional]

- nota: *at least one out of this attribute and "numberingOrg" should be set*

(XPath FASCatalog/FCbody/FCgroup/FCitem/fashionProd/csRange/color/@codeList) [Optional]

- nota: *this attribute should be used either single or coupled with "listName" and "listVersion"*

(XPath FASCatalog/FCbody/FCgroup/FCitem/fashionProd/garmentCode/garmentCodeB/color/@codeList) [Optional]

- nota: *this attribute should be used either single or coupled with "listName" and "listVersion"*

(XPath FASCatalog/FCheader/season/@codeList) [Optional] (a)

- nota: *this attribute should be used either single or coupled with "listName" and "listVersion"*

(XPath FASCatalog/FCbody/FCgroup/FCitem/garmentCategory/season/@codeList) [Optional]

- nota: *this attribute should be used either single or coupled with "listName" and "listVersion"*

(XPath FASCatalog/FCbody/FCgroup/FCitem/garmentCategory/goodsClassification/macroClass/@codeList) [Optional] (a)

- nota: *at least one out of this attribute and "numberingOrg" should be set*

(XPath FASCatalog/FCbody/FCgroup/FCitem/fashionProd/note/@codeList) [Optional]

- nota: *must be used to provide (URL) the list of codes used in "noteLabel"*

(XPath FASCatalog/FCbody/FCgroup/FCitem/garmentCategory/goodsClassification/class/@codeList) [Optional] (a)

- nota: *at least one out of this attribute and "numberingOrg" should be set*

(XPath FASCatalog/FCbody/FCgroup/FCitem/garmentCategory/artSex/@codeList) [Optional]

- nota: *at least one out of this attribute and "numberingOrg" should be set*

(XPath FASCatalog/FCbody/FCgroup/FCitem/operationalCode/@codeList) [Optional] (a)

- nota: *at least one out of this attribute and "numberingOrg" should be set*

(XPath FASCatalog/FCbody/FCgroup/FCitem/productLine/@codeList) [Optional] (a)

- nota: *at least one out of this attribute and "numberingOrg" should be set*

(XPath FASCatalog/FCbody/FCgroup/FCitem/unitOfMeasure/@codeList) [Optional] (Default= [http://www.ebiz.enea.it/moda-ml/repository/codelist/v2013-1/gc\\_NT7.xml](http://www.ebiz.enea.it/moda-ml/repository/codelist/v2013-1/gc_NT7.xml)) (a)

- nota: *Codes from tabel NT7 are suggested.*

(XPath FASCatalog/FCbody/FCgroup/FCitem/garmentCategory/artSubGroup/@codeList) [Optional]

- nota: *at least one out of this attribute and "numberingOrg" should be set*

(XPath FASCatalog/FCbody/FCgroup/FCitem/garmentCategory/artGroup/@codeList) [Optional]

- nota: *at least one out of this attribute and "numberingOrg" should be set*

(XPath FASCatalog/FCbody/FCgroup/FCitem/fashionProd/csRange/sizeMatrix/sizeRow/size/@codeList) [Optional]

(XPath FASCatalog/FCbody/FCgroup/FCitem/fashionProd/yarnCode/color/@codeList) [Optional]

- nota: *this attribute should be used either single or coupled with "listName" and "listVersion"*

(XPath FASCatalog/FCbody/FCgroup/FCitem/fashionProd/texCode/art/@codeList) [Optional]

- nota: *at least one out of this attribute and "numberingOrg" should be set*

(XPath FASCatalog/FCbody/FCgroup/FCitem/fashionProd/csRange/sizeMatrix/sizeRow/drop/@codeList) [Optional]

(XPath FASCatalog/FCbody/FCgroup/FCitem/fashionProd/texCode/pattern/@codeList) [Optional]

- nota: *at least one out of this attribute and "numberingOrg" should be set*

(XPath FASCatalog/FCbody/FCgroup/FCitem/fashionProd/yarnCode/art/@codeList) [Optional]

- nota: *at least one out of this attribute and "numberingOrg" should be set*

(XPath FASCatalog/FCbody/FCgroup/FCitem/garmentCategory/note/@codeList) [Optional]

- nota: *must be used to provide (URL) the list of codes used in "noteLabel"*

(XPath FASCatalog/FCbody/FCgroup/FCitem/garmentCategory/goodsClassification/subClass/@codeList) [Optional] (a)

- nota: *at least one out of this attribute and "numberingOrg" should be set*

(XPath FASCatalog/FCbody/FCgroup/FCitem/fashionProd/additionalComponentCode/@codeList) [Optional]

- nota: *at least one out of this attribute and "numberingOrg" should be set*

(XPath FASCatalog/FCbody/FCgroup/FCitem/fashionProd/csRange/sizeMatrix/sizeRow/itemsList/qualityLevel/@codeList) [Optional] (a)

- nota: *at least one out of this attribute and "numberingOrg" should be set*

(XPath FASCatalog/FCheader/picture/note/@codeList) [Optional]

- nota: *must be used to provide (URL) the list of codes used in "noteLabel"*

(XPath FASCatalog/FCbody/FCgroup/FCitem/dtScheme/legalRef/@codeList) [Optional] (a)

(XPath FASCatalog/FCbody/FCgroup/FCitem/garComInfo/note/@codeList) [Optional]

- nota: *must be used to provide (URL) the list of codes used in "noteLabel"*

(XPath FASCatalog/FCbody/FCgroup/note/@codeList) [Optional]

- nota: *must be used to provide (URL) the list of codes used in "noteLabel"*

(XPath FASCatalog/FCbody/FCgroup/FCitem/dtScheme/note/@codeList) [Optional]

- nota: *must be used to provide (URL) the list of codes used in "noteLabel"*

(XPath FASCatalog/FCbody/FCgroup/FCitem/note/@codeList) [Optional]

- nota: *must be used to provide (URL) the list of codes used in "noteLabel"*

(XPath FASCatalog/garComInfo/season/@codeList) [Optional] (a)

- nota: *this attribute should be used either single or coupled with "listName" and "listVersion"*

(XPath FASCatalog/FCheader/note/@codeList) [Optional]

- nota: *must be used to provide (URL) the list of codes used in "noteLabel"*

(XPath FASCatalog/garComInfo/brand/@codeList) [Optional] (a)

- nota: *at least one out of this attribute and "numberingOrg" should be set*

(XPath FASCatalog/FCbody/FCgroup/FCitem/garComInfo/acsPack/acsPackCode/@codeList) [Optional] (a)

- nota: *at least one out of this attribute and "numberingOrg" should be set*

(XPath FASCatalog/terms/allowanceCharge/dtScheme/legalRef/@codeList) [Optional] (a)

(XPath FASCatalog/garComInfo/productLine/@codeList) [Optional] (a)

- nota: *at least one out of this attribute and "numberingOrg" should be set*

(XPath FASCatalog/terms/allowanceCharge/dtScheme/note/@codeList) [Optional]

- nota: *must be used to provide (URL) the list of codes used in "noteLabel"*

(XPath FASCatalog/FCbody/FCgroup/FCitem/garComInfo/garPack/garPackCode/@codeList) [Optional] (a)

- nota: *at least one out of this attribute and "numberingOrg" should be set*

(XPath FASCatalog/garComInfo/operationalCode/@codeList) [Optional] (a)

- nota: *at least one out of this attribute and "numberingOrg" should be set*

<b>@codeQualifier</b>	<p>operational code qualifier: it states if the code is related to a project, an event, an initiative, a sales channel, a management type (eg CITES), .....</p> <p>- base type: string, cod. table: NT43  <a href="http://www.ebiz.enea.it/moda-ml/repository/codelist/v2018-1/gc_NT43.xml">http://www.ebiz.enea.it/moda-ml/repository/codelist/v2018-1/gc_NT43.xml</a>  (XPath FASCatalog/FCbody/FCgroup/FCitem/operationalCode/@codeQualifier) [Optional] (Na)  (XPath FASCatalog/FCbody/FCgroup/garComInfo/operationalCode/@codeQualifier) [Optional] (Na)  (XPath FASCatalog/garComInfo/operationalCode/@codeQualifier) [Optional] (Na)  (XPath FASCatalog/FCbody/FCgroup/FCitem/garComInfo/operationalCode/@codeQualifier) [Optional] (N)</p>
<b>color</b>	<p>colour number of the product, when not included in the model or fabric code</p> <p>- base type: string, max length: 15,  (XPath FASCatalog/FCbody/FCgroup/FCitem/fashionProdcRange/color) 0-1</p> <p>- note: <i>used only if not already specified in the article code</i>  (XPath FASCatalog/FCbody/FCgroup/FCitem/fashionProdcacsCode/color) 0-1  (XPath FASCatalog/FCbody/FCgroup/FCitem/fashionProdcstexCode/color) 0-1  (XPath FASCatalog/FCbody/FCgroup/FCitem/fashionProdcgarmentPartCode/color) 0-1</p> <p>- note: <i>when a garment component, it should be the code assigned to the garment article</i>  (XPath FASCatalog/FCbody/FCgroup/FCitem/fashionProdcgarmentCode/garmentCodeB/color) 0-1  (XPath FASCatalog/FCbody/FCgroup/FCitem/fashionProdcyarnCode/color) 0-1</p>
<b>conversionRate</b>	<p>Conversion parameter between two sizes.</p> <p>- base type: decimal,  (XPath FASCatalog/FCbody/FCgroup/FCitem/measureConversion/conversionRate) 1-1 (N)</p> <p>- note: <i>Use: (quantity expressed in the source unit of measure) * conversion Rate = (quantity expressed in the target unit of measure)</i></p>
<b>country</b>	<p>code of the nation</p> <p>- base type: string, cod. table: T10  <a href="http://www.ebiz.enea.it/moda-ml/repository/codelist/v2018-1/gc_T10.xml">http://www.ebiz.enea.it/moda-ml/repository/codelist/v2018-1/gc_T10.xml</a>  (XPath FASCatalog/FCheader/thirdParty/country) 0-1  (XPath FASCatalog/FCheader/buyer/country) 0-1  (XPath FASCatalog/FCheader/supplier/country) 0-1</p>
<b>@currency</b>	<p>currency in which a specified monetary data is expressed</p> <p>- base type: string, cod. table: T9  <a href="http://www.ebiz.enea.it/moda-ml/repository/codelist/v2018-1/gc_T9.xml">http://www.ebiz.enea.it/moda-ml/repository/codelist/v2018-1/gc_T9.xml</a>  (XPath FASCatalog/terms/allowanceCharge/AC_amount/@currency) [Optional] (a)  (XPath FASCatalog/FCbody/FCgroup/FCitem/allowanceCharge/@currency) [Optional] (a)  (XPath FASCatalog/FCbody/FCgroup/FCitem/allowanceCharge/AC_amount/@currency) [Optional]  (XPath FASCatalog/terms/allowanceCharge/@currency) [Optional] (a)  (XPath FASCatalog/FCbody/FCgroup/FCitem/marketPrice/catalogPrice/@currency) [Optional]</p> <p>- nota: <i>Currency referred by the price.</i>  (XPath FASCatalog/FCbody/FCgroup/allowanceCharge/AC_amount/@currency) [Optional]  (XPath FASCatalog/FCbody/FCgroup/allowanceCharge/@currency) [Optional] (a)  (XPath FASCatalog/FCbody/FCgroup/FCitem/marketPrice/allowanceCharge/@currency) [Optional]  (XPath FASCatalog/FCbody/FCgroup/FCitem/marketPrice/allowanceCharge/AC_amount/@currency) [Optional] (a)</p>

<p>@dateForm</p>	<p>format used for the date</p> <ul style="list-style-type: none"> <li>- base type: string, cod. table: NT29</li> <li><a href="http://www.ebiz.enea.it/moda-ml/repository/codelist/v2018-1/gc_NT29.xml">http://www.ebiz.enea.it/moda-ml/repository/codelist/v2018-1/gc_NT29.xml</a></li> <li>(XPath FASCatalog/FCheader/refDoc/docDate/@dateForm) [Optional]</li> <li>(XPath FASCatalog/FCbody/FCgroup/FCitem/picture/validityEnd/@dateForm) [Optional]</li> <li>(XPath FASCatalog/terms/transInfo/delEffectiveDate/@dateForm) [Optional]</li> <li>(XPath FASCatalog/garComInfo/deliveryDate/@dateForm) [Optional]</li> <li>(XPath FASCatalog/FCbody/FCgroup/FCitem/garComInfo/deliveryDate/@dateForm) [Optional]</li> <li>(XPath FASCatalog/FCbody/FCgroup/garComInfo/specDate/@dateForm) [Optional]</li> <li>(XPath FASCatalog/terms/transInfo/despatchDate/@dateForm) [Optional] (a)</li> <li>(XPath FASCatalog/FCbody/FCgroup/FCitem/picture/validityStart/@dateForm) [Optional]</li> <li>(XPath FASCatalog/FCbody/FCgroup/picture/validityStart/@dateForm) [Optional]</li> <li>(XPath FASCatalog/FCheader/msgDate/@dateForm) [Optional]</li> <li>(XPath FASCatalog/FCbody/FCgroup/FCitem/garComInfo/specDate/@dateForm) [Optional]</li> <li>(XPath FASCatalog/FCbody/FCgroup/FCitem/refDoc/docDate/@dateForm) [Optional]</li> <li>(XPath FASCatalog/FCheader/validityStart/@dateForm) [Optional]</li> <li>(XPath FASCatalog/FCheader/validityEnd/@dateForm) [Optional]</li> <li>(XPath FASCatalog/FCbody/FCgroup/garComInfo/deliveryDate/@dateForm) [Optional]</li> <li>(XPath FASCatalog/FCbody/FCgroup/picture/validityEnd/@dateForm) [Optional]</li> <li>(XPath FASCatalog/FCheader/picture/validityEnd/@dateForm) [Optional]</li> <li>(XPath FASCatalog/FCheader/picture/validityStart/@dateForm) [Optional]</li> <li>(XPath FASCatalog/garComInfo/specDate/@dateForm) [Optional]</li> <li>(XPath FASCatalog/FCbody/FCgroup/refDoc/docDate/@dateForm) [Optional]</li> </ul>
<p>delEffectiveDate</p>	<p>effective date of delivery of goods (declared in Despatch), according to one of the patterns YYYY-MM-DD, YYYY-MM-DD:HH-MM or YYYY-WW.</p> <ul style="list-style-type: none"> <li>- base type: string,</li> <li>(XPath FASCatalog/terms/transInfo/delEffectiveDate) 0-1 (p)</li> </ul>
<p>deliveryDate</p>	<p>date of delivery of goods, requested or promised in the purchase process, according to one of the patterns YYYY-MM-DD, YYYY-MM-DD:HH-MM or YYYY-WW.</p> <ul style="list-style-type: none"> <li>- base type: string,</li> <li>(XPath FASCatalog/FCbody/FCgroup/FCitem/garComInfo/deliveryDate) 0-1 (p)</li> <li>(XPath FASCatalog/FCbody/FCgroup/garComInfo/deliveryDate) 0-1 (p)</li> <li>(XPath FASCatalog/garComInfo/deliveryDate) 0-1 (p)</li> </ul>
<p>deliveryPlace</p>	<p>place of delivery of goods, ultimate or related to a given leg</p> <ul style="list-style-type: none"> <li>- base type: string, max length: 250,</li> <li>(XPath FASCatalog/terms/transInfo/deliveryPlace) 0-1 (U)</li> </ul>
<p>dept</p>	<p>name or code of a contact department within a Party</p> <ul style="list-style-type: none"> <li>- base type: string, max length: 40,</li> <li>(XPath FASCatalog/FCheader/supplier/dept) 0-1</li> <li>(XPath FASCatalog/FCheader/buyer/dept) 0-1</li> <li>(XPath FASCatalog/FCheader/thirdParty/dept) 0-1</li> </ul>
<p>description</p>	<p>free text description. The content of the element must be unique, it might be translated and repeated into more languages (thus no more than one instance for each language).</p> <ul style="list-style-type: none"> <li>- base type: string, max length: 250,</li> <li>(XPath FASCatalog/FCbody/FCgroup/picture/description) 0-unbounded (AU)</li> <li>- note: <i>Only one instance of this element for each different value of 'ln' attribute (language)</i></li> <li>(XPath FASCatalog/FCbody/FCgroup/description) 0-unbounded (AU)</li> <li>- note: <i>group description</i></li> <li>(XPath FASCatalog/FCbody/FCgroup/FCitem/fashionProd/garmentCode/garmentCodeA/description) 0-unbounded (AU)</li> <li>- note: <i>Product description</i></li> <li>(XPath FASCatalog/FCbody/FCgroup/FCitem/fashionProd/garmentCode/garmentCodeB/description) 0-unbounded (AU)</li> </ul>

	<p>- note: <i>Product description</i> (XPath FASCatalog/FCbody/FCgroup/FCitem/picture/description) 0-unbounded (AU)</p> <p>- note: <i>Only one instance of this element for each different value of 'ln' attribute (language)</i> (XPath FASCatalog/FCheader/picture/description) 0-unbounded (AU)</p> <p>- note: <i>Only one instance of this element for each different value of 'ln' attribute (language)</i> (XPath FASCatalog/FCbody/FCgroup/FCitem/fashionProd/garmentPartCode/description) 0-unbounded (AU)</p> <p>- note: <i>Product part description</i> (XPath FASCatalog/FCbody/FCgroup/FCitem/composition/description) 0-unbounded (AU)</p> <p>- note: <i>Free text description of the composition of the product or its part</i> (XPath FASCatalog/FCbody/FCgroup/FCitem/fashionProd/acsCode/description) 0-unbounded (AU)</p> <p>- note: <i>Product description</i> (XPath FASCatalog/FCbody/FCgroup/FCitem/packages/description) 0-unbounded (AU)</p> <p>(XPath FASCatalog/FCbody/FCgroup/FCitem/fashionProd/yarnCode/description) 0-unbounded (AU)</p> <p>- note: <i>Product description</i> (XPath FASCatalog/FCbody/FCgroup/FCitem/fashionProd/texCode/description) 0-unbounded (AU)</p> <p>- note: <i>Product description</i></p>
despatchDate	<p>date of despatch of goods, requested or promised in the purchase process, according to one of the patterns YYYY-MM-DD, YYYY-MM-DD:HH-MM or YYY-WW.</p> <p>- base type: string, (XPath FASCatalog/terms/transInfo/despatchDate) 0-1 (N)</p>
despatchPlace	<p>place of despatch of goods, origin or related to a given leg</p> <p>- base type: string, max length: 250, (XPath FASCatalog/terms/transInfo/despatchPlace) 0-1 (N)</p>
docDate	<p>date of issue of the referenced document, according to one of the patterns YYYY-MM-DD, YYYY-MM-DD:HH-MM or YYYY-WW.</p> <p>- base type: string, (XPath FASCatalog/FCheader/refDoc/docDate) 0-1 (XPath FASCatalog/FCbody/FCgroup/FCitem/refDoc/docDate) 0-1 (XPath FASCatalog/FCbody/FCgroup/refDoc/docDate) 0-1</p>
docID	<p>identification number of the referenced document SINCE 2008-1 ITS USE I N THE HEADER IS DISCOURAGED (REPLACED BY msgID)</p> <p>- base type: string, max length: 80, (XPath FASCatalog/FCheader/refDoc/docID) 1-2 (p)</p> <hr/> <p>AAAA-WARNING! - text not AVAILABLE n. 245 - ln=en (XPath FASCatalog/FCbody/FCgroup/FCitem/refDoc/docID) 1-2 (p)</p> <hr/> <p>AAAA-WARNING! - text not AVAILABLE n. 245 - ln=en (XPath FASCatalog/FCbody/FCgroup/refDoc/docID) 1-2 (p)</p> <hr/> <p>AAAA-WARNING! - text not AVAILABLE n. 245 - ln=en</p>
@docType	<p>type or class to which the referenced document belongs</p> <p>- base type: string, cod. table: T21 <a href="http://www.ebiz.enea.it/moda-ml/repository/codelist/v2018-1/gc_T21.xml">http://www.ebiz.enea.it/moda-ml/repository/codelist/v2018-1/gc_T21.xml</a> (XPath FASCatalog/FCheader/refDoc/@docType) [Required] (XPath FASCatalog/FCbody/FCgroup/FCitem/refDoc/@docType) [Required] (XPath FASCatalog/FCbody/FCgroup/refDoc/@docType) [Required]</p>
drop	<p>drop number of the garment</p> <p>- base type: string, max length: 15, (XPath FASCatalog/FCbody/FCgroup/FCitem/fashionProd/csRange/sizeMatrix/sizeRow/drop) 0-1 (A)</p>

	<p>- note: <i>DEPRECATED</i>, anyhow it is used only if not already specified in the article code or csRange (XPath FASCatalog/FCbody/FCgroup/FCitem/fashionProd/garmentCode/garmentCodeB/drop) 0-1 (A)</p> <p>- note: Fill this element if the drop is the same for all the sizes of the model. Otherway specify it within the csRange element (XPath FASCatalog/FCbody/FCgroup/FCitem/fashionProd/csRange/drop) 0-1 (A)</p> <p>- note: used only if not already specified in the article code</p>
@email	<p>electronic mail address of the contact person within a Party</p> <p>- base type: string, max length: 250, (XPath FASCatalog/FCheader/buyer/person/@email) [Optional] (XPath FASCatalog/FCheader/supplier/person/@email) [Optional] (XPath FASCatalog/FCheader/thirdParty/person/@email) [Optional]</p>
@encoding	<p>specifies the decoding algorithm of the binary object</p> <p>- base type: normalizedString, (XPath FASCatalog/FCbody/FCgroup/refDoc/attachment/binaryObject/@encoding) [Optional] (N) (XPath FASCatalog/FCbody/FCgroup/picture/attachment/binaryObject/@encoding) [Optional] (N) (XPath FASCatalog/FCheader/refDoc/attachment/binaryObject/@encoding) [Optional] (Na) (XPath FASCatalog/FCheader/picture/attachment/binaryObject/@encoding) [Optional] (Na) (XPath FASCatalog/FCbody/FCgroup/FCitem/refDoc/attachment/binaryObject/@encoding) [Optional] (Na) (XPath FASCatalog/FCbody/FCgroup/FCitem/picture/attachment/binaryObject/@encoding) [Optional] (Na)</p>
encodingCode	<p>the encoding/decoding algorithm used with the external object (example is 'base64Binary')</p> <p>- base type: normalizedString, (XPath FASCatalog/FCbody/FCgroup/picture/attachment/externalReference/encodingCode) 0-1 (N) (XPath FASCatalog/FCbody/FCgroup/refDoc/attachment/externalReference/encodingCode) 0-1 (N) (XPath FASCatalog/FCbody/FCgroup/FCitem/picture/attachment/externalReference/encodingCode) 0-1 (N) (XPath FASCatalog/FCheader/picture/attachment/externalReference/encodingCode) 0-1 (N) (XPath FASCatalog/FCheader/refDoc/attachment/externalReference/encodingCode) 0-1 (N) (XPath FASCatalog/FCbody/FCgroup/FCitem/refDoc/attachment/externalReference/encodingCode) 0-1 (N)</p>
@endUse	<p>specifies the final use of the fabric</p> <p>- base type: string, cod. table: NT4 <a href="http://www.ebiz.enea.it/moda-ml/repository/codelist/v2018-1/gc_NT4.xml">http://www.ebiz.enea.it/moda-ml/repository/codelist/v2018-1/gc_NT4.xml</a> (XPath FASCatalog/garComInfo/@endUse) [Optional] (a)</p> <p>- nota: When used for garments, use only PR: Production or SA: Sample codes. (XPath FASCatalog/FCbody/FCgroup/FCitem/garComInfo/@endUse) [Optional] (a)</p> <p>- nota: When used for garments, use only PR: Production or SA: Sample codes. (XPath FASCatalog/FCbody/FCgroup/garComInfo/@endUse) [Optional] (a)</p> <p>- nota: When used for garments, use only PR: Production or SA: Sample codes.</p>
EPC	<p>serial identifier used for tracing a physical item with RFID technology</p> <p>- base type: string, (XPath FASCatalog/FCbody/FCgroup/FCitem/packages/EPCList/EPC) 1-unbounded</p>

extendedDescription	<p>extended free text description. The content of the element must be unique, it might be translated and repeated into more languages (thus no more than one instance for each language). This element might contain HTML code (must be managed as CDATA)</p> <p>- base type: string, (XPath FASCatalog/FCbody/FCgroup/extendedDescription) 0-unbounded (N)</p> <p>- note: <i>group extended description</i> (XPath FASCatalog/FCbody/FCgroup/FCitem/extendedDescription) 0-unbounded (N)</p> <p>- note: <i>Extended product description</i></p>
fabric	<p>fabric number of the garment</p> <p>- base type: string, max length: 15, (XPath FASCatalog/FCbody/FCgroup/FCitem/fashionProd/garmentCode/garmentCodeB/fabric) 0-1 (XPath FASCatalog/FCbody/FCgroup/FCitem/fashionProd/garmentPartCode/fabric) 0-1</p> <p>- note: <i>when a garment component, it should be the code assigned to the garment article</i></p>
@fax	<p>fax number of the contact person within a Party</p> <p>- base type: string, max length: 35, (XPath FASCatalog/FCheader/supplier/person/@fax) [Optional] (XPath FASCatalog/FCheader/buyer/person/@fax) [Optional] (XPath FASCatalog/FCheader/thirdParty/person/@fax) [Optional]</p>
@fibre	<p>type of fibre used in a textile product</p> <p>- base type: string, cod. table: T19 <a href="http://www.ebiz.enea.it/moda-ml/repository/codelist/v2018-1/gc_T19.xml">http://www.ebiz.enea.it/moda-ml/repository/codelist/v2018-1/gc_T19.xml</a> (XPath FASCatalog/FCbody/FCgroup/FCitem/composition/garmentCompos/percCompos/@fibre) [Required]</p>
fileName	<p>unique identifier (name) of the file</p> <p>- base type: string, max length: 255, (XPath FASCatalog/FCbody/FCgroup/FCitem/refDoc/attachment/fileName) 0-1 (N) (XPath FASCatalog/FCbody/FCgroup/picture/attachment/fileName) 0-1 (N) (XPath FASCatalog/FCbody/FCgroup/refDoc/attachment/fileName) 0-1 (N) (XPath FASCatalog/FCbody/FCgroup/FCitem/picture/attachment/fileName) 0-1 (N) (XPath FASCatalog/FCheader/refDoc/attachment/fileName) 0-1 (N) (XPath FASCatalog/FCheader/picture/attachment/fileName) 0-1 (N)</p>
fillingCriterion	<p>the assortment criterion to fill the specified kind of package: it states the homogeneity criterion (eg: "model", "color", "size").</p> <p>- base type: string, cod. table: NT51 <a href="http://www.ebiz.enea.it/moda-ml/repository/codelist/v2018-1/gc_NT51.xml">http://www.ebiz.enea.it/moda-ml/repository/codelist/v2018-1/gc_NT51.xml</a> (XPath FASCatalog/FCbody/FCgroup/FCitem/packages/fillingCriterion) 0-9 (N)</p>
@finDiscount	<p>financial discount rate applied for payment by the date specified</p> <p>- base type: decimal, min inclusive: 0, max inclusive: 100, fraction digits: 2, (XPath FASCatalog/terms/payment/@finDiscount) [Optional]</p>
@finSurcharge	<p>financial surcharge rate applied for payment after the date specified</p> <p>- base type: decimal, min inclusive: 0, max inclusive: 100, fraction digits: 2, (XPath FASCatalog/terms/payment/@finSurcharge) [Optional]</p>
@format	<p>the format of the binary content (examples xml, pdf, doc,...)</p> <p>- base type: string, (XPath FASCatalog/FCbody/FCgroup/FCitem/picture/attachment/binaryObject/@format) [Optional] (Na) (XPath FASCatalog/FCheader/picture/attachment/binaryObject/@format) [Optional] (Na) (XPath FASCatalog/FCbody/FCgroup/FCitem/refDoc/attachment/binaryObject/@format) [Optional] (Na) (XPath FASCatalog/FCheader/refDoc/attachment/binaryObject/@format) [Optional] (Na)</p>



	<p>(XPath FASCatalog/FCbody/FCgroup/picture/attachment/binaryObject/@format) [Optional] (N)</p> <p>(XPath FASCatalog/FCbody/FCgroup/refDoc/attachment/binaryObject/@format) [Optional] (N)</p>
formatCode	<p>the format of the external object (examples xml, pdf, doc,...)</p> <p>- base type: normalizedString,</p> <p>(XPath FASCatalog/FCheader/picture/attachment/externalReference/formatCode) 0-1 (N)</p> <p>(XPath FASCatalog/FCbody/FCgroup/FCitem/refDoc/attachment/externalReference/formatCode) 0-1 (N)</p> <p>(XPath FASCatalog/FCbody/FCgroup/refDoc/attachment/externalReference/formatCode) 0-1 (N)</p> <p>(XPath FASCatalog/FCbody/FCgroup/FCitem/picture/attachment/externalReference/formatCode) 0-1 (N)</p> <p>(XPath FASCatalog/FCheader/refDoc/attachment/externalReference/formatCode) 0-1 (N)</p> <p>(XPath FASCatalog/FCbody/FCgroup/picture/attachment/externalReference/formatCode) 0-1 (N)</p>
@garmentMarket	<p>market segment for the product</p> <p>- base type: string, min length: 0, max length: 255,</p> <p>(XPath FASCatalog/FCbody/FCgroup/FCitem/marketPrice/catalogPrice/@garmentMarket) [Optional]</p>
garPackCode	<p>a code specifying the type of packaging used for the item.</p> <p>- base type: string,</p> <p>(XPath FASCatalog/FCbody/FCgroup/FCitem/packages/handlingChar/garPack/garPackCode) 1-1 (N)</p> <p>(XPath FASCatalog/garComInfo/garPack/garPackCode) 1-1 (N)</p> <p>(XPath FASCatalog/FCbody/FCgroup/garComInfo/garPack/garPackCode) 1-1 (N)</p> <p>(XPath FASCatalog/FCbody/FCgroup/FCitem/garComInfo/garPack/garPackCode) 1-1 (N)</p>
garPackText	<p>a free text specifying the type of packaging used for the item.</p> <p>- base type: string,</p> <p>(XPath FASCatalog/FCbody/FCgroup/FCitem/packages/handlingChar/garPack/garPackText) 1-1 (N)</p> <p>(XPath FASCatalog/FCbody/FCgroup/garComInfo/garPack/garPackText) 1-1 (N)</p> <p>(XPath FASCatalog/garComInfo/garPack/garPackText) 1-1 (N)</p> <p>(XPath FASCatalog/FCbody/FCgroup/FCitem/garComInfo/garPack/garPackText) 1-1 (N)</p>
geographicAreaCode	<p>code identifying a geographic area</p> <p>- base type: string, cod. table: T10</p> <p><a href="http://www.ebiz.enea.it/moda-ml/repository/codelist/v2018-1/gc_T10.xml">http://www.ebiz.enea.it/moda-ml/repository/codelist/v2018-1/gc_T10.xml</a></p> <p>(XPath FASCatalog/FCbody/FCgroup/FCitem/marketPrice/geographicArea/geographicAreaCode) 1-1 (N)</p>
geographicAreaText	<p>text identifying a geographic area</p> <p>- base type: string,</p> <p>(XPath FASCatalog/FCbody/FCgroup/FCitem/marketPrice/geographicArea/geographicAreaText) 1-1 (N)</p> <hr/> <p>AAAA-WARNING! - text not AVAILABLE n. 245 - In=en</p>
gPart	<p>code specifying the type of component or part of a fashion product (sleeve, neck, ...)</p> <p>- base type: string, cod. table: T48</p> <p><a href="http://www.ebiz.enea.it/moda-ml/repository/codelist/v2018-1/gc_T48.xml">http://www.ebiz.enea.it/moda-ml/repository/codelist/v2018-1/gc_T48.xml</a></p> <p>(XPath FASCatalog/FCbody/FCgroup/FCitem/fashionProd/garmentPartCode/gPart) 1-1</p>
grossWeight	<p>the gross weight, declared for transport or customs purpose</p> <p>- base type: decimal, min inclusive: 0, fraction digits: 2,</p> <p>(XPath FASCatalog/terms/transInfo/grossWeight) 0-1</p>

	(XPath FASCatalog/FCbody/FCgroup/FCitem/packages/handlingChar/grossWeight) 0-1
handlingType	information to handle the item (eg "breakable"). - base type: string, (XPath FASCatalog/FCbody/FCgroup/FCitem/packages/handlingChar/handlingType) 0-1 (N)
height	effective height of a specified object - base type: decimal, min inclusive: 0, fraction digits: 2, (XPath FASCatalog/FCbody/FCgroup/picture/height) 0-1 - note: the 'um' attribute of this element must be 'E37' (pixel) (XPath FASCatalog/FCbody/FCgroup/FCitem/picture/height) 0-1 - note: the 'um' attribute of this element must be 'E37' (pixel) (XPath FASCatalog/FCbody/FCgroup/FCitem/productDim/height) 0-1 (p) (XPath FASCatalog/FCbody/FCgroup/FCitem/packages/packageDim/height) 0-1 (XPath FASCatalog/FCheader/picture/height) 0-1 - note: the 'um' attribute of this element must be 'E37' (pixel)
id	primary identification code of a Party; it is recommended the format: nation code (ISO 3166) + VAT identification number (11 crt), with the qualifier "numberingOrg"= MF - base type: string, max length: 15, (XPath FASCatalog/FCheader/thirdParty/id) 1-1 (XPath FASCatalog/FCheader/buyer/id) 1-1 (p) (XPath FASCatalog/FCheader/supplier/id) 1-1
@idQualifier	Qualification of the identifier. - base type: string, (XPath FASCatalog/FCheader/buyer/additionalIdentifier/@idQualifier) [Optional] (Na) - nota: this attribute should be used when the numberingOrg attribute is not enough to declare the type of identifier (XPath FASCatalog/FCheader/supplier/additionalIdentifier/@idQualifier) [Optional] (Na) - nota: this attribute should be used when the numberingOrg attribute is not enough to declare the type of identifier (XPath FASCatalog/FCbody/FCgroup/FCitem/fashionPro/csRange/sizeMatrix/sizeRow/itemsList/itemIdentification/serialN/@idQualifier) [Optional] (N) - nota: this attribute should be used when the numberingOrg attribute is not enough to declare the type of serial identifier
incoTerm	specification of the terms of trade (INCOTERMS) - base type: string, cod. table: T3 <a href="http://www.ebiz.enea.it/moda-ml/repository/codelist/v2018-1/gc_T3.xml">http://www.ebiz.enea.it/moda-ml/repository/codelist/v2018-1/gc_T3.xml</a> (XPath FASCatalog/terms/trade/incoTerm) 1-1
incoTermText	free text specifying the terms of trade (incoterm, location) - base type: string, max length: 250, (XPath FASCatalog/terms/trade/incoTermText) 1-1 (U)
@isCharge	Indicates if the element to which it refers is a charge (true = charge, false = allowance) - base type: boolean, min length: 0, (XPath FASCatalog/terms/allowanceCharge/@isCharge) [Optional] (N) (XPath FASCatalog/FCbody/FCgroup/FCitem/allowanceCharge/@isCharge) [Optional] (N) (XPath FASCatalog/FCbody/FCgroup/allowanceCharge/@isCharge) [Optional] (N) (XPath FASCatalog/FCbody/FCgroup/FCitem/marketPrice/allowanceCharge/@isCharge) [Optional] (N)
@isURL	it indicates if the referred element is an URL (true) or not (false) - base type: boolean, (XPath FASCatalog/FCbody/FCgroup/FCitem/picture/attachment/externalReference/uri/@isURL) [Optional] [Default= true] (Na)

	<p>- nota: <i>usage of URLs is recommended</i> (XPath FASCatalog/FCheader/refDoc/attachment/externalReference/uri/@isURL) [Optional] [Default= true] (Na)</p> <p>- nota: <i>usage of URLs is recommended</i> (XPath FASCatalog/FCbody/FCgroup/FCitem/refDoc/attachment/externalReference/uri/@isURL) [Optional] [Default= true] (Na)</p> <p>- nota: <i>usage of URLs is recommended</i> (XPath FASCatalog/FCbody/FCgroup/picture/attachment/externalReference/uri/@isURL) [Optional] [Default= true] (Na)</p> <p>- nota: <i>usage of URLs is recommended</i> (XPath FASCatalog/FCbody/FCgroup/refDoc/attachment/externalReference/uri/@isURL) [Optional] [Default= true] (Na)</p> <p>- nota: <i>usage of URLs is recommended</i> (XPath FASCatalog/FCheader/picture/attachment/externalReference/uri/@isURL) [Optional] [Default= true] (Na)</p> <p>- nota: <i>usage of URLs is recommended</i></p>
itemID	<p>number of the line/item of the referenced document</p> <p>- base type: string, max length: 40, (XPath FASCatalog/FCheader/refDoc/itemID) 0-1 (U) (XPath FASCatalog/FCbody/FCgroup/refDoc/itemID) 0-1 (U) (XPath FASCatalog/FCbody/FCgroup/FCitem/refDoc/itemID) 0-1 (U)</p>
itemsPerPackage	<p>the quantity of items that can be contained in a package.</p> <p>- base type: decimal, (XPath FASCatalog/FCbody/FCgroup/FCitem/packages/itemsPerPackage) 0-1 (N)</p>
label	<p>indicates if the physical object specified has to be labelled</p> <p>- base type: boolean, (XPath FASCatalog/garComInfo/yarnPack/yarnInWrap/label) 0-1 (XPath FASCatalog/FCbody/FCgroup/garComInfo/yarnPack/yarnInWrap/label) 0-1 (XPath FASCatalog/garComInfo/yarnPack/yarnReel/label) 0-1 (XPath FASCatalog/FCbody/FCgroup/FCitem/packages/handlingChar/yarnPack/yarnInWrap/label) 0-1 (XPath FASCatalog/FCbody/FCgroup/FCitem/packages/handlingChar/yarnPack/yarnReel/label) 0-1 (XPath FASCatalog/FCbody/FCgroup/FCitem/garComInfo/yarnPack/yarnInWrap/label) 0-1 (XPath FASCatalog/FCbody/FCgroup/FCitem/garComInfo/yarnPack/yarnReel/label) 0-1 (XPath FASCatalog/FCbody/FCgroup/garComInfo/yarnPack/yarnReel/label) 0-1</p>
labelWrit	<p>text that must be written on the lable of a specified physical object when its customization is required</p> <p>- base type: string, max length: 350, (XPath FASCatalog/FCbody/FCgroup/FCitem/packages/handlingChar/yarnPack/yarnInWrap/labelWrit) 0-1 (XPath FASCatalog/FCbody/FCgroup/FCitem/packages/handlingChar/yarnPack/yarnReel/labelWrit) 0-1 (XPath FASCatalog/FCbody/FCgroup/FCitem/garComInfo/yarnPack/yarnInWrap/labelWrit) 0-1 (XPath FASCatalog/garComInfo/yarnPack/yarnReel/labelWrit) 0-1 (XPath FASCatalog/FCbody/FCgroup/FCitem/garComInfo/yarnPack/yarnReel/labelWrit) 0-1 (XPath FASCatalog/FCbody/FCgroup/garComInfo/yarnPack/yarnInWrap/labelWrit) 0-1 (XPath FASCatalog/FCbody/FCgroup/garComInfo/yarnPack/yarnReel/labelWrit) 0-1 (XPath FASCatalog/garComInfo/yarnPack/yarnInWrap/labelWrit) 0-1</p>
legalName	<p>legal name of a Party</p> <p>- base type: string, max length: 250, (XPath FASCatalog/FCheader/thirdParty/legalName) 0-1 (U)</p>

	(XPath FASCatalog/FCheader/buyer/legalName) 0-1 (U) (XPath FASCatalog/FCheader/supplier/legalName) 0-1 (U)
legalRef	legal reference of the duty or tax or fee category - base type: string, (XPath FASCatalog/FCbody/FCgroup/FCitem/allowanceCharge/ dtScheme/legalRef) 0-1 (A) (XPath FASCatalog/terms/allowanceCharge/dtScheme/legalRef) 0-1 (A) (XPath FASCatalog/FCbody/FCgroup/FCitem/dtScheme/legalRef) 0-1 (A) (XPath FASCatalog/FCbody/FCgroup/allowanceCharge/dtScheme/legalRef) 0-1 (A) (XPath FASCatalog/FCbody/FCgroup/FCitem/marketPrice/ allowanceCharge/dtScheme/legalRef) 0-1 (A)
length	effective length of a specified object - base type: decimal, min inclusive: 0, fraction digits: 2, (XPath FASCatalog/FCbody/FCgroup/FCitem/packages/ packageDim/length) 1-1 - note: <i>here the maximum dimension must also be specified</i> (XPath FASCatalog/FCbody/FCgroup/FCitem/productDim/length) 1-1 (p)
lineID	unique identifier of the line item of the business document; it is set by the role that produces the document. - base type: string, max length: 30, (XPath FASCatalog/FCbody/FCgroup/FCitem/lineID) 0-1 (N)
lineN	number of the line item of the present message (xml document); it is set by the role that produces the document. Usually it is a progressive number, but not always. - base type: positiveInteger, min inclusive: 1, max inclusive: 9999, (XPath FASCatalog/FCbody/FCgroup/FCitem/lineN) 0-1
@listName	the name of the list of codes used to make an instance of the element (it might be thought as descriptive element, i.e. 'fabric printing technologies', or not, i.e. "T264") - base type: string, max length: 40, (XPath FASCatalog/FCbody/FCgroup/FCitem/garComInfo/ operationalCode/@listName) [Optional] - nota: <i>this attribute should always be used coupled with "numberingOrg"</i> (XPath FASCatalog/FCbody/FCgroup/FCitem/garComInfo/ garPack/garPackCode/@listName) [Optional] (a) - nota: <i>this attribute should always be used coupled with "numberingOrg"</i> (XPath FASCatalog/FCbody/FCgroup/FCitem/measureConversion/ unitOfSourceMeasure/@listName) [Optional] [Default= NT7] (XPath FASCatalog/FCbody/FCgroup/FCitem/fashionProd/ garmentCode/garmentCodeB/garmentVariant/variantType/@listName) [Optional] (a) - nota: <i>this attribute should always be used coupled with "numberingOrg"</i> (XPath FASCatalog/FCbody/FCgroup/FCitem/brand/@listName) [Optional] (a) - nota: <i>this attribute should always be used coupled with "numberingOrg"</i> (XPath FASCatalog/FCbody/FCgroup/FCitem/measureConversion/ unitOfTargetMeasure/@listName) [Optional] [Default= NT7] (XPath FASCatalog/FCbody/FCgroup/FCitem/operationalCode/@listName) [Optional] (a) - nota: <i>this attribute should always be used coupled with "numberingOrg"</i> (XPath FASCatalog/FCbody/FCgroup/artGroup/@listName) [Optional] - nota: <i>this attribute should always be used coupled with "numberingOrg"</i> (XPath FASCatalog/FCbody/FCgroup/FCitem/productLine/@listName) [Optional] (a) - nota: <i>this attribute should always be used coupled with "numberingOrg"</i> (XPath FASCatalog/FCbody/FCgroup/FCitem/fashionProd/ garmentCode/garmentCodeA/art/@listName) [Optional] - nota: <i>this attribute should always be used coupled with "numberingOrg"</i> (XPath FASCatalog/FCbody/FCgroup/FCitem/fashionProd/ garmentPartCode/mod/@listName) [Optional] - nota: <i>this attribute should always be used coupled with "numberingOrg"</i> (XPath FASCatalog/terms/allowanceCharge/dtScheme/legalRef/@listName) [Optional] (a)

- nota: *this attribute should always be used coupled with “numberingOrg”* (XPath FASCatalog/FCbody/FCgroup/FCitem/garComInfo/season/@listName) [Optional] (a)
- nota: *this attribute should always be used coupled with “numberingOrg”* (XPath FASCatalog/FCbody/FCgroup/FCitem/fashionProd/garmentPartCode/color/@listName) [Optional]
- nota: *this attribute should always be used coupled with “numberingOrg”* (XPath FASCatalog/FCbody/FCgroup/FCitem/garComInfo/productLine/@listName) [Optional]
- nota: *this attribute should always be used coupled with “numberingOrg”* (XPath FASCatalog/FCbody/FCgroup/FCitem/fashionProd/garmentPartCode/fabric/@listName) [Optional]
- nota: *this attribute should always be used coupled with “numberingOrg”* (XPath FASCatalog/FCbody/FCgroup/FCitem/fashionProd/acsCode/color/@listName) [Optional]
- nota: *this attribute should always be used coupled with “numberingOrg”* (XPath FASCatalog/FCbody/FCgroup/FCitem/fashionProd/garmentCode/garmentCodeB/size/@listName) [Optional] (a)
- nota: *this attribute should always be used coupled with “numberingOrg”* (XPath FASCatalog/FCbody/FCgroup/FCitem/fashionProd/csRange/drop/@listName) [Optional] (a)
- nota: *this attribute should always be used coupled with “numberingOrg”* (XPath FASCatalog/FCbody/FCgroup/FCitem/marketPrice/allowanceCharge/dtScheme/legalRef/@listName) [Optional] (a)
- nota: *this attribute should always be used coupled with “numberingOrg”* (XPath FASCatalog/FCbody/FCgroup/FCitem/fashionProd/csRange/sizeMatrix/sizeRow/itemsList/qualityLevel/@listName) [Optional] (a)
- nota: *this attribute should always be used coupled with “numberingOrg”* (XPath FASCatalog/FCbody/FCgroup/FCitem/fashionProd/yarnCode/art/@listName) [Optional]
- nota: *this attribute should always be used coupled with “numberingOrg”* (XPath FASCatalog/FCbody/FCgroup/FCitem/allowanceCharge/dtScheme/legalRef/@listName) [Optional] (a)
- nota: *this attribute should always be used coupled with “numberingOrg”* (XPath FASCatalog/FCbody/FCgroup/FCitem/fashionProd/additionalComponentCode/@listName) [Optional]
- nota: *this attribute should always be used coupled with “numberingOrg”* (XPath FASCatalog/FCbody/FCgroup/FCitem/garmentCategory/goodsClassification/subClass/@listName) [Optional] (a)
- nota: *this attribute should always be used coupled with “numberingOrg”* (XPath FASCatalog/FCbody/FCgroup/refDoc/season/@listName) [Optional] (a)
- nota: *this attribute should always be used coupled with “numberingOrg”* (XPath FASCatalog/FCbody/FCgroup/FCitem/fashionProd/texCode/color/@listName) [Optional]
- nota: *this attribute should always be used coupled with “numberingOrg”* (XPath FASCatalog/FCbody/FCgroup/FCitem/dtScheme/legalRef/@listName) [Optional] (a)
- nota: *this attribute should always be used coupled with “numberingOrg”* (XPath FASCatalog/FCbody/FCgroup/FCitem/fashionProd/csRange/sizeMatrix/sizeRow/drop/@listName) [Optional] (a)
- nota: *this attribute should always be used coupled with “numberingOrg”* (XPath FASCatalog/FCbody/FCgroup/FCitem/fashionProd/texCode/art/@listName) [Optional]
- nota: *this attribute should always be used coupled with “numberingOrg”* (XPath FASCatalog/FCbody/FCgroup/FCitem/fashionProd/garmentCode/garmentCodeB/garmentVariant/variantCode/@listName) [Optional] (a)
- nota: *this attribute should always be used coupled with “numberingOrg”* (XPath FASCatalog/FCbody/FCgroup/FCitem/fashionProd/yarnCode/color/@listName) [Optional]
- nota: *this attribute should always be used coupled with “numberingOrg”* (XPath FASCatalog/FCbody/FCgroup/FCitem/fashionProd/csRange/sizeMatrix/sizeRow/size/@listName) [Optional] (a)
- nota: *this attribute should always be used coupled with “numberingOrg”*

(XPath FASCatalog/FCbody/FCgroup/FCitem/fashionProd/texCode/pattern/@listName) [Optional]

- nota: *this attribute should always be used coupled with “numberingOrg”*  
(XPath FASCatalog/FCheader/season/@listName) [Optional] (a)

- nota: *this attribute should always be used coupled with “numberingOrg”*  
(XPath FASCatalog/FCbody/FCgroup/FCitem/garmentCategory/artSex/@listName) [Optional]

- nota: *this attribute should always be used coupled with “numberingOrg”*  
(XPath FASCatalog/FCheader/refDoc/season/@listName) [Optional] (a)

- nota: *this attribute should always be used coupled with “numberingOrg”*  
(XPath FASCatalog/FCbody/FCgroup/FCitem/garmentCategory/artSubGroup/@listName) [Optional]

- nota: *this attribute should always be used coupled with “numberingOrg”*  
(XPath FASCatalog/FCbody/FCgroup/FCitem/unitOfMeasure/@listName) [Optional] [Default= NT7] (a)

(XPath FASCatalog/FCbody/FCgroup/FCitem/fashionProd/acsCode/pattern/@listName) [Optional]

- nota: *this attribute should always be used coupled with “numberingOrg”*  
(XPath FASCatalog/FCbody/FCgroup/FCitem/garmentCategory/artGroup/@listName) [Optional]

- nota: *this attribute should always be used coupled with “numberingOrg”*  
(XPath FASCatalog/FCbody/FCgroup/FCitem/fashionProd/acsCode/art/@listName) [Optional]

- nota: *this attribute should always be used coupled with “numberingOrg”*  
(XPath FASCatalog/FCbody/FCgroup/FCitem/fashionProd/csRange/sizeMatrix/sizeRow/additionalComponentCode/@listName) [Optional] (a)

- nota: *this attribute should always be used coupled with “numberingOrg”*  
(XPath FASCatalog/FCbody/FCgroup/FCitem/garmentCategory/goodsClassification/class/@listName) [Optional] (a)

- nota: *this attribute should always be used coupled with “numberingOrg”*  
(XPath FASCatalog/FCbody/FCgroup/FCitem/garmentCategory/goodsClassification/macroClass/@listName) [Optional] (a)

- nota: *this attribute should always be used coupled with “numberingOrg”*  
(XPath FASCatalog/garComInfo/operationalCode/@listName) [Optional] (a)

- nota: *this attribute should always be used coupled with “numberingOrg”*  
(XPath FASCatalog/FCbody/FCgroup/FCitem/garmentCategory/season/@listName) [Optional]

- nota: *this attribute should always be used coupled with “numberingOrg”*  
(XPath FASCatalog/FCbody/FCgroup/FCitem/fashionProd/garmentCode/garmentCodeB/drop/@listName) [Optional] (a)

- nota: *this attribute should always be used coupled with “numberingOrg”*  
(XPath FASCatalog/FCbody/FCgroup/FCitem/fashionProd/garmentCode/garmentCodeB/artGroup/@listName) [Optional]

- nota: *this attribute should always be used coupled with “numberingOrg”*  
(XPath FASCatalog/FCbody/FCgroup/garComInfo/brand/@listName) [Optional] (a)

- nota: *this attribute should always be used coupled with “numberingOrg”*  
(XPath FASCatalog/FCbody/FCgroup/garComInfo/productLine/@listName) [Optional] (a)

- nota: *this attribute should always be used coupled with “numberingOrg”*  
(XPath FASCatalog/FCbody/FCgroup/allowanceCharge/dtScheme/legalRef/@listName) [Optional] (a)

- nota: *this attribute should always be used coupled with “numberingOrg”*  
(XPath FASCatalog/FCbody/FCgroup/garComInfo/operationalCode/@listName) [Optional] (a)

- nota: *this attribute should always be used coupled with “numberingOrg”*  
(XPath FASCatalog/FCbody/FCgroup/garComInfo/acsPack/acsPackCode/@listName) [Optional]

- nota: *this attribute should always be used coupled with “numberingOrg”*  
(XPath FASCatalog/FCbody/FCgroup/FCitem/packages/handlingChar/acsPack/acsPackCode/@listName) [Optional] (a)

- nota: *this attribute should always be used coupled with “numberingOrg”*  
(XPath FASCatalog/FCbody/FCgroup/FCitem/fashionProd/csRange/garmentVariant/variantType/@listName) [Optional] (a)

	<ul style="list-style-type: none"> <li>- nota: <i>this attribute should always be used coupled with “numberingOrg”</i> (XPath FASCatalog/FCbody/FCgroup/FCitem/fashionProd/ garmentCode/garmentCodeB/color/@listName) [Optional]</li> <li>- nota: <i>this attribute should always be used coupled with “numberingOrg”</i> (XPath FASCatalog/FCbody/FCgroup/FCitem/garComInfo/brand/@listName) [Optional] (a)</li> <li>- nota: <i>this attribute should always be used coupled with “numberingOrg”</i> (XPath FASCatalog/FCbody/FCgroup/garComInfo/garPack/ garPackCode/@listName) [Optional]</li> <li>- nota: <i>this attribute should always be used coupled with “numberingOrg”</i> (XPath FASCatalog/FCbody/FCgroup/FCitem/garComInfo/ acsPack/acsPackCode/@listName) [Optional] (a)</li> <li>- nota: <i>this attribute should always be used coupled with “numberingOrg”</i> (XPath FASCatalog/FCbody/FCgroup/FCitem/fashionProd/ garmentPartCode/size/@listName) [Optional] (a)</li> <li>- nota: <i>this attribute should always be used coupled with “numberingOrg”</i> (XPath FASCatalog/FCbody/FCgroup/FCitem/fashionProd/ garmentCode/garmentCodeB/fabric/@listName) [Optional]</li> <li>- nota: <i>this attribute should always be used coupled with “numberingOrg”</i> (XPath FASCatalog/FCbody/FCgroup/FCitem/fashionProd/ csRange/color/@listName) [Optional]</li> <li>- nota: <i>this attribute should always be used coupled with “numberingOrg”</i> (XPath FASCatalog/garComInfo/acsPack/acsPackCode/@listName) [Optional] (a)</li> <li>- nota: <i>this attribute should always be used coupled with “numberingOrg”</i> (XPath FASCatalog/garComInfo/brand/@listName) [Optional] (a)</li> <li>- nota: <i>this attribute should always be used coupled with “numberingOrg”</i> (XPath FASCatalog/FCbody/FCgroup/FCitem/fashionProd/ csRange/garmentVariant/variantCode/@listName) [Optional] (a)</li> <li>- nota: <i>this attribute should always be used coupled with “numberingOrg”</i> (XPath FASCatalog/garComInfo/garPack/garPackCode/@listName) [Optional] (a)</li> <li>- nota: <i>this attribute should always be used coupled with “numberingOrg”</i> (XPath FASCatalog/FCbody/FCgroup/FCitem/fashionProd/ garmentCode/garmentCodeB/mod/@listName) [Optional]</li> <li>- nota: <i>this attribute should always be used coupled with “numberingOrg”</i> (XPath FASCatalog/garComInfo/season/@listName) [Optional] (a)</li> <li>- nota: <i>this attribute should always be used coupled with “numberingOrg”</i> (XPath FASCatalog/FCbody/FCgroup/FCitem/refDoc/season/@listName) [Optional] (a)</li> <li>- nota: <i>this attribute should always be used coupled with “numberingOrg”</i> (XPath FASCatalog/garComInfo/productLine/@listName) [Optional] (a)</li> <li>- nota: <i>this attribute should always be used coupled with “numberingOrg”</i> (XPath FASCatalog/FCbody/FCgroup/FCitem/packages/ handlingChar/garPack/garPackCode/@listName) [Optional] (a)</li> <li>- nota: <i>this attribute should always be used coupled with “numberingOrg”</i> (XPath FASCatalog/FCbody/FCgroup/garComInfo/season/@listName) [Optional] (a)</li> <li>- nota: <i>this attribute should always be used coupled with “numberingOrg”</i></li> </ul>
<p>@listVersion</p>	<p>it specifie the version of the list of codes used to make an instance of the element</p> <ul style="list-style-type: none"> <li>- base type: string, max length: 6, (XPath FASCatalog/FCbody/FCgroup/FCitem/garmentCategory/ goodsClassification/subClass/@listVersion) [Optional] (a)</li> <li>- nota: <i>this attribute should always be used coupled with “numberingOrg” and “listName”</i> (XPath FASCatalog/FCbody/FCgroup/FCitem/fashionProd/ csRange/sizeMatrix/sizeRow/additionalComponentCode/@listVersion) [Optional] (a)</li> <li>- nota: <i>this attribute should always be used coupled with “numberingOrg” and “listName”</i> (XPath FASCatalog/FCbody/FCgroup/FCitem/garmentCategory/ goodsClassification/class/@listVersion) [Optional] (a)</li> <li>- nota: <i>this attribute should always be used coupled with “numberingOrg” and “listName”</i> (XPath FASCatalog/FCbody/FCgroup/FCitem/fashionProd/ garmentCode/garmentCodeB/drop/@listVersion) [Optional] (a)</li> </ul>

- nota: *this attribute should always be used coupled with “numberingOrg” and “listName”*  
 (XPath FASCatalog/FCbody/FCgroup/FCitem/garmentCategory/artSex/@listVersion) [Optional]

- nota: *this attribute should always be used coupled with “numberingOrg” and “listName”*  
 (XPath FASCatalog/FCbody/FCgroup/FCitem/fashionProd/garmentCode/garmentCodeB/artGroup/@listVersion) [Optional]

- nota: *this attribute should always be used coupled with “numberingOrg” and “listName”*  
 (XPath FASCatalog/FCbody/FCgroup/FCitem/garmentCategory/artSubGroup/@listVersion) [Optional]

- nota: *this attribute should always be used coupled with “numberingOrg” and “listName”*  
 (XPath FASCatalog/FCbody/FCgroup/FCitem/fashionProd/acsCode/art/@listVersion) [Optional]

- nota: *this attribute should always be used coupled with “numberingOrg” and “listName”*  
 (XPath FASCatalog/FCbody/FCgroup/FCitem/garmentCategory/goodsClassification/macroClass/@listVersion) [Optional] (a)

- nota: *this attribute should always be used coupled with “numberingOrg” and “listName”*  
 (XPath FASCatalog/FCbody/FCgroup/FCitem/packages/handlingChar/acsPack/acsPackCode/@listVersion) [Optional] (a)

- nota: *this attribute should always be used coupled with “numberingOrg” and “listName”*  
 (XPath FASCatalog/FCbody/FCgroup/garComInfo/operationalCode/@listVersion) [Optional] (a)

- nota: *this attribute should always be used coupled with “numberingOrg” and “listName”*  
 (XPath FASCatalog/FCbody/FCgroup/FCitem/garmentCategory/season/@listVersion) [Optional]

- nota: *this attribute should always be used coupled with “numberingOrg” and “listName”*  
 (XPath FASCatalog/garComInfo/season/@listVersion) [Optional] (a)

- nota: *this attribute should always be used coupled with “numberingOrg” and “listName”*  
 (XPath FASCatalog/FCbody/FCgroup/FCitem/fashionProd/yarnCode/color/@listVersion) [Optional]

- nota: *this attribute should always be used coupled with “numberingOrg” and “listName”*  
 (XPath FASCatalog/FCbody/FCgroup/FCitem/fashionProd/csRange/sizeMatrix/sizeRow/size/@listVersion) [Optional] (a)

- nota: *this attribute should always be used coupled with “numberingOrg” and “listName”*  
 (XPath FASCatalog/FCbody/FCgroup/FCitem/fashionProd/yarnCode/art/@listVersion) [Optional]

- nota: *this attribute should always be used coupled with “numberingOrg” and “listName”*  
 (XPath FASCatalog/FCbody/FCgroup/refDoc/season/@listVersion) [Optional] (a)

- nota: *this attribute should always be used coupled with “numberingOrg” and “listName”*  
 (XPath FASCatalog/FCbody/FCgroup/FCitem/fashionProd/garmentCode/garmentCodeB/garmentVariant/variantCode/@listVersion) [Optional] (a)

- nota: *this attribute should always be used coupled with “numberingOrg” and “listName”*  
 (XPath FASCatalog/FCbody/FCgroup/FCitem/fashionProd/garmentCode/garmentCodeB/fabric/@listVersion) [Optional]

- nota: *this attribute should always be used coupled with “numberingOrg” and “listName”*  
 (XPath FASCatalog/FCbody/FCgroup/FCitem/fashionProd/texCode/art/@listVersion) [Optional]



- nota: *this attribute should always be used coupled with “numberingOrg” and “listName”*  
(XPath FASCatalog/FCbody/FCgroup/FCitem/fashionProd/csRange/sizeMatrix/sizeRow/drop/@listVersion) [Optional] (a)

- nota: *this attribute should always be used coupled with “numberingOrg” and “listName”*  
(XPath FASCatalog/FCbody/FCgroup/FCitem/fashionProd/texCode/pattern/@listVersion) [Optional]

- nota: *this attribute should always be used coupled with “numberingOrg” and “listName”*  
(XPath FASCatalog/FCbody/FCgroup/FCitem/allowanceCharge/dtScheme/legalRef/@listVersion) [Optional] (a)

- nota: *this attribute should always be used coupled with “numberingOrg” and “listName”*  
(XPath FASCatalog/FCbody/FCgroup/FCitem/packages/handlingChar/garPack/garPackCode/@listVersion) [Optional] (a)

- nota: *this attribute should always be used coupled with “numberingOrg” and “listName”*  
(XPath FASCatalog/FCbody/FCgroup/FCitem/fashionProd/texCode/color/@listVersion) [Optional]

- nota: *this attribute should always be used coupled with “numberingOrg” and “listName”*  
(XPath FASCatalog/FCbody/FCgroup/FCitem/fashionProd/csRange/sizeMatrix/sizeRow/itemsList/qualityLevel/@listVersion) [Optional] (a)

- nota: *this attribute should always be used coupled with “numberingOrg” and “listName”*  
(XPath FASCatalog/FCbody/FCgroup/FCitem/fashionProd/csRange/color/@listVersion) [Optional]

- nota: *this attribute should always be used coupled with “numberingOrg” and “listName”*  
(XPath FASCatalog/FCbody/FCgroup/FCitem/fashionProd/garmentCode/garmentCodeB/mod/@listVersion) [Optional]

- nota: *this attribute should always be used coupled with “numberingOrg” and “listName”*  
(XPath FASCatalog/FCbody/FCgroup/FCitem/garComInfo/brand/@listVersion) [Optional] (a)

- nota: *this attribute should always be used coupled with “numberingOrg” and “listName”*  
(XPath FASCatalog/FCbody/FCgroup/garComInfo/garPack/garPackCode/@listVersion) [Optional]

- nota: *this attribute should always be used coupled with “numberingOrg” and “listName”*  
(XPath FASCatalog/FCbody/FCgroup/FCitem/garComInfo/productLine/@listVersion) [Optional]

- nota: *this attribute should always be used coupled with “numberingOrg” and “listName”*  
(XPath FASCatalog/garComInfo/operationalCode/@listVersion) [Optional] (a)

- nota: *this attribute should always be used coupled with “numberingOrg” and “listName”*  
(XPath FASCatalog/FCbody/FCgroup/garComInfo/acsPack/acsPackCode/@listVersion) [Optional]

- nota: *this attribute should always be used coupled with “numberingOrg” and “listName”*  
(XPath FASCatalog/FCbody/FCgroup/FCitem/fashionProd/additionalComponentCode/@listVersion) [Optional]

- nota: *this attribute should always be used coupled with “numberingOrg” and “listName”*  
(XPath FASCatalog/FCbody/FCgroup/FCitem/dtScheme/legalRef/@listVersion) [Optional] (a)

- nota: *this attribute should always be used coupled with “numberingOrg” and “listName”*  
(XPath FASCatalog/FCbody/FCgroup/FCitem/garComInfo/acsPack/acsPackCode/@listVersion) [Optional] (a)

- nota: *this attribute should always be used coupled with “numberingOrg” and “listName”*  
(XPath FASCatalog/FCbody/FCgroup/FCitem/fashionProd/garmentPartCode/size/@listVersion) [Optional] (a)

- nota: *this attribute should always be used coupled with “numberingOrg” and “listName”*  
(XPath FASCatalog/FCbody/FCgroup/FCitem/fashionProd/acsCode/color/@listVersion) [Optional]

- nota: *this attribute should always be used coupled with “numberingOrg” and “listName”*  
(XPath FASCatalog/FCbody/FCgroup/FCitem/garComInfo/season/@listVersion) [Optional] (a)

- nota: *this attribute should always be used coupled with “numberingOrg” and “listName”*  
(XPath FASCatalog/terms/allowanceCharge/dtScheme/legalRef/@listVersion) [Optional] (a)

- nota: *this attribute should always be used coupled with “numberingOrg” and “listName”*  
(XPath FASCatalog/FCbody/FCgroup/FCitem/garComInfo/operationalCode/@listVersion) [Optional]

- nota: *this attribute should always be used coupled with “numberingOrg” and “listName”*  
(XPath FASCatalog/FCbody/FCgroup/FCitem/fashionProd/garmentCode/garmentCodeB/color/@listVersion) [Optional]

- nota: *this attribute should always be used coupled with “numberingOrg” and “listName”*  
(XPath FASCatalog/FCbody/FCgroup/FCitem/brand/@listVersion) [Optional] (a)

- nota: *this attribute should always be used coupled with “numberingOrg” and “listName”*  
(XPath FASCatalog/garComInfo/acsPack/acsPackCode/@listVersion) [Optional] (a)

- nota: *this attribute should always be used coupled with “numberingOrg” and “listName”*  
(XPath FASCatalog/FCbody/FCgroup/garComInfo/season/@listVersion) [Optional] (a)

- nota: *this attribute should always be used coupled with “numberingOrg” and “listName”*  
(XPath FASCatalog/FCbody/FCgroup/FCitem/measureConversion/unitOfSourceMeasure/@listVersion) [Optional]  
(XPath FASCatalog/FCbody/FCgroup/FCitem/fashionProd/csRange/drop/@listVersion) [Optional] (a)

- nota: *this attribute should always be used coupled with “numberingOrg” and “listName”*  
(XPath FASCatalog/garComInfo/productLine/@listVersion) [Optional] (a)

- nota: *this attribute should always be used coupled with “numberingOrg” and “listName”*  
(XPath FASCatalog/FCbody/FCgroup/FCitem/fashionProd/csRange/garmentVariant/variantCode/@listVersion) [Optional] (a)

- nota: *this attribute should always be used coupled with “numberingOrg” and “listName”*  
(XPath FASCatalog/FCbody/FCgroup/FCitem/fashionProd/garmentCode/garmentCodeB/size/@listVersion) [Optional] (a)

- nota: *this attribute should always be used coupled with “numberingOrg” and “listName”*  
(XPath FASCatalog/garComInfo/garPack/garPackCode/@listVersion) [Optional] (a)

- nota: *this attribute should always be used coupled with “numberingOrg” and “listName”*  
(XPath FASCatalog/FCbody/FCgroup/FCitem/fashionProd/garmentPartCode/color/@listVersion) [Optional]

- nota: *this attribute should always be used coupled with “numberingOrg” and “listName”*  
(XPath FASCatalog/FCbody/FCgroup/FCitem/measureConversion/unitOfTargetMeasure/@listVersion) [Optional]  
(XPath FASCatalog/FCbody/FCgroup/FCitem/fashionProd/garmentPartCode/mod/@listVersion) [Optional]

- nota: *this attribute should always be used coupled with “numberingOrg” and “listName”*  
(XPath FASCatalog/FCbody/FCgroup/FCitem/fashionProd/csRange/garmentVariant/variantType/@listVersion) [Optional] (a)

- nota: *this attribute should always be used coupled with “numberingOrg” and “listName”*  
(XPath FASCatalog/FCbody/FCgroup/FCitem/marketPrice/allowanceCharge/dtScheme/legalRef/@listVersion) [Optional] (a)

- nota: *this attribute should always be used coupled with “numberingOrg” and “listName”*  
(XPath FASCatalog/FCbody/FCgroup/FCitem/fashionProd/garmentPartCode/fabric/@listVersion) [Optional]

- nota: *this attribute should always be used coupled with “numberingOrg” and “listName”*  
(XPath FASCatalog/FCbody/FCgroup/allowanceCharge/dtScheme/legalRef/@listVersion) [Optional] (a)

- nota: *this attribute should always be used coupled with “numberingOrg” and “listName”*  
(XPath FASCatalog/FCheader/refDoc/season/@listVersion) [Optional] (a)

- nota: *this attribute should always be used coupled with “numberingOrg” and “listName”*  
(XPath FASCatalog/FCbody/FCgroup/FCitem/refDoc/season/@listVersion) [Optional] (a)

- nota: *this attribute should always be used coupled with “numberingOrg” and “listName”*  
(XPath FASCatalog/FCbody/FCgroup/FCitem/fashionProd/acsCode/pattern/@listVersion) [Optional]

- nota: *this attribute should always be used coupled with “numberingOrg” and “listName”*  
(XPath FASCatalog/FCbody/FCgroup/FCitem/garComInfo/garPack/garPackCode/@listVersion) [Optional] (a)

- nota: *this attribute should always be used coupled with “numberingOrg” and “listName”*  
(XPath FASCatalog/FCbody/FCgroup/FCitem/operationalCode/@listVersion) [Optional] (a)

- nota: *this attribute should always be used coupled with “numberingOrg” and “listName”*  
(XPath FASCatalog/FCbody/FCgroup/FCitem/fashionProd/garmentCode/garmentCodeA/art/@listVersion) [Optional]

- nota: *this attribute should always be used coupled with “numberingOrg” and “listName”*  
(XPath FASCatalog/FCheader/season/@listVersion) [Optional] (a)

- nota: *this attribute should always be used coupled with “numberingOrg” and “listName”*  
(XPath FASCatalog/FCbody/FCgroup/FCitem/fashionProd/garmentCode/garmentCodeB/garmentVariant/variantType/@listVersion) [Optional] (a)

- nota: *this attribute should always be used coupled with “numberingOrg” and “listName”*  
(XPath FASCatalog/FCbody/FCgroup/FCitem/garmentCategory/artGroup/@listVersion) [Optional]

- nota: *this attribute should always be used coupled with “numberingOrg” and “listName”*  
(XPath FASCatalog/FCbody/FCgroup/artGroup/@listVersion) [Optional]

- nota: *this attribute should always be used coupled with “numberingOrg” and “listName”*  
(XPath FASCatalog/FCbody/FCgroup/garComInfo/productLine/@listVersion) [Optional] (a)

- nota: *this attribute should always be used coupled with “numberingOrg” and “listName”*  
(XPath FASCatalog/FCbody/FCgroup/FCitem/unitOfMeasure/@listVersion) [Optional] (a)

(XPath FASCatalog/FCbody/FCgroup/garComInfo/brand/@listVersion) [Optional] (a)

	<p>- nota: <i>this attribute should always be used coupled with “numberingOrg” and “listName”</i>  (XPath FASCatalog/FCbody/FCgroup/FCitem/productLine/@listVersion) [Optional] (a)</p> <p>- nota: <i>this attribute should always be used coupled with “numberingOrg” and “listName”</i>  (XPath FASCatalog/garComInfo/brand/@listVersion) [Optional] (a)</p> <p>- nota: <i>this attribute should always be used coupled with “numberingOrg” and “listName”</i></p>
@ln	<p>Language code.</p> <p>- base type: string, cod. table: NT60  <a href="http://www.ebiz.enea.it/moda-ml/repository/codelist/v2018-1/gc_NT60.xml">http://www.ebiz.enea.it/moda-ml/repository/codelist/v2018-1/gc_NT60.xml</a>  (XPath FASCatalog/FCheader/picture/title/@ln) [Optional] (Na)  (XPath FASCatalog/FCbody/FCgroup/FCitem/picture/alternativeText/@ln) [Optional] (N)  (XPath FASCatalog/FCbody/FCgroup/FCitem/fashionProd/yarnCode/description/@ln) [Optional] (N)  (XPath FASCatalog/FCbody/FCgroup/FCitem/picture/title/@ln) [Optional] (Na)  (XPath FASCatalog/FCbody/FCgroup/FCitem/picture/description/@ln) [Optional] (N)  (XPath FASCatalog/FCbody/FCgroup/description/@ln) [Optional] (N)  (XPath FASCatalog/FCbody/FCgroup/FCitem/composition/description/@ln) [Optional] (N)  (XPath FASCatalog/FCbody/FCgroup/FCitem/fashionProd/garmentCode/garmentCodeA/description/@ln) [Optional] (N)  (XPath FASCatalog/FCbody/FCgroup/FCitem/packages/handlingChar/handlingType/@ln) [Optional] (Na)  (XPath FASCatalog/FCbody/FCgroup/FCitem/fashionProd/garmentPartCode/description/@ln) [Optional] (N)  (XPath FASCatalog/FCheader/picture/description/@ln) [Optional] (N)  (XPath FASCatalog/FCbody/FCgroup/FCitem/packages/description/@ln) [Optional] (N)  (XPath FASCatalog/FCbody/FCgroup/picture/title/@ln) [Optional] (Na)  (XPath FASCatalog/FCbody/FCgroup/FCitem/extendedDescription/@ln) [Optional] (Na)  (XPath FASCatalog/FCbody/FCgroup/FCitem/fashionProd/texCode/description/@ln) [Optional] (N)  (XPath FASCatalog/FCbody/FCgroup/picture/alternativeText/@ln) [Optional] (Na)  (XPath FASCatalog/FCheader/picture/alternativeText/@ln) [Optional] (Na)  (XPath FASCatalog/FCbody/FCgroup/FCitem/fashionProd/acsCode/description/@ln) [Optional] (N)  (XPath FASCatalog/FCbody/FCgroup/FCitem/fashionProd/garmentCode/garmentCodeB/description/@ln) [Optional] (N)  (XPath FASCatalog/FCbody/FCgroup/picture/description/@ln) [Optional] (N)  (XPath FASCatalog/FCbody/FCgroup/extendedDescription/@ln) [Optional] (Na)</p>
location	<p>specification of a location</p> <p>- base type: string, max length: 40,  (XPath FASCatalog/terms/trade/location) 0-1</p> <p>- note: <i>place to which the INCOTERM applies</i></p>
@logo	<p>company logo (URL of the image jpeg or gif). It is recommended that the width of the image does not exceed 640 pixel.</p> <p>- base type: string, max length: 255,  (XPath FASCatalog/FCheader/supplier/@logo) [Optional]  (XPath FASCatalog/FCheader/buyer/@logo) [Optional]</p>
@LRI	<p>attribute usable to format a string according to a customized User rule (local rule)</p> <p>- base type: string, cod. table: NT3  <a href="http://www.ebiz.enea.it/moda-ml/repository/codelist/v2018-1/gc_NT3.xml">http://www.ebiz.enea.it/moda-ml/repository/codelist/v2018-1/gc_NT3.xml</a>  (XPath FASCatalog/terms/trade/location/@LRI) [Optional]</p>

macroClass	<p>a code indicating the category (macro-class, class or sub-class) of a commodity classification system the article belongs to.</p> <p>- base type: string,  (XPath FASCatalog/FCbody/FCgroup/FCitem/garmentCategory/goodsClassification/macroClass) 0-1 (N)</p>
@maxQty	<p>maximum product quantity</p> <p>- base type: decimal, min inclusive: 0, fraction digits: 2,  (XPath FASCatalog/terms/allowanceCharge/@maxQty) [Optional] (N)</p> <p>- nota: <i>maximum quantity of product for the application of this allowance or charge</i>  (XPath FASCatalog/FCbody/FCgroup/FCitem/marketPrice/catalogPrice/@maxQty) [Optional] (N)</p> <p>- nota: <i>maximum quantity of product for the application of this price</i>  (XPath FASCatalog/FCbody/FCgroup/FCitem/marketPrice/allowanceCharge/@maxQty) [Optional] (N)</p> <p>- nota: <i>maximum quantity of product for the application of this allowance or charge</i>  (XPath FASCatalog/FCbody/FCgroup/FCitem/allowanceCharge/@maxQty) [Optional] (N)</p> <p>- nota: <i>maximum quantity of product for the application of this allowance or charge</i>  (XPath FASCatalog/FCbody/FCgroup/allowanceCharge/@maxQty) [Optional] (N)</p> <p>- nota: <i>maximum quantity of product for the application of this allowance or charge</i></p>
@measureQualifier	<p>Unit of measure qualifier.</p> <p>- base type: string,  (XPath FASCatalog/FCbody/FCgroup/FCitem/measureConversion/unitOfTargetMeasure/@measureQualifier) [Optional] (N)  (XPath FASCatalog/FCbody/FCgroup/FCitem/measureConversion/unitOfSourceMeasure/@measureQualifier) [Optional] (N)  (XPath FASCatalog/FCbody/FCgroup/FCitem/unitOfMeasure/@measureQualifier) [Optional] (Na)</p>
@mime	<p>the mime type of the binary object</p> <p>- base type: normalizedString,  (XPath FASCatalog/FCbody/FCgroup/FCitem/picture/attachment/binaryObject/@mime) [Optional] (Na)  (XPath FASCatalog/FCheader/refDoc/attachment/binaryObject/@mime) [Optional] (Na)  (XPath FASCatalog/FCbody/FCgroup/refDoc/attachment/binaryObject/@mime) [Optional] (N)  (XPath FASCatalog/FCheader/picture/attachment/binaryObject/@mime) [Optional] (Na)  (XPath FASCatalog/FCbody/FCgroup/picture/attachment/binaryObject/@mime) [Optional] (N)  (XPath FASCatalog/FCbody/FCgroup/FCitem/refDoc/attachment/binaryObject/@mime) [Optional] (Na)</p>
mimeCode	<p>mime type of the external object</p> <p>- base type: normalizedString,  (XPath FASCatalog/FCbody/FCgroup/FCitem/picture/attachment/externalReference/mimeCode) 0-1 (N)</p> <hr/> <p>AAAA-WARNING! - text not AVAILABLE n. 245 - In=en  (XPath FASCatalog/FCheader/refDoc/attachment/externalReference/mimeCode) 0-1 (N)</p> <hr/> <p>AAAA-WARNING! - text not AVAILABLE n. 245 - In=en  (XPath FASCatalog/FCbody/FCgroup/refDoc/attachment/externalReference/mimeCode) 0-1 (N)</p> <hr/> <p>AAAA-WARNING! - text not AVAILABLE n. 245 - In=en  (XPath FASCatalog/FCbody/FCgroup/FCitem/refDoc/attachment/externalReference/mimeCode) 0-1 (N)</p>

	<p>AAAA-WARNING! - text not AVAILABLE n. 245 - In=en (XPath FASCatalog/FCbody/FCgroup/picture/attachment/externalReference/mimeCode) 0-1 (N)</p> <hr/> <p>AAAA-WARNING! - text not AVAILABLE n. 245 - In=en (XPath FASCatalog/FCheader/picture/attachment/externalReference/mimeCode) 0-1 (N)</p> <hr/> <p>AAAA-WARNING! - text not AVAILABLE n. 245 - In=en</p>
minItemsPerPackage	<p>the minimum quantity of items for the specified kind of package. - base type: decimal, min inclusive: 0, (XPath FASCatalog/FCbody/FCgroup/FCitem/packages/minItemsPerPackage) 0-1 (N)</p>
@minQty	<p>minimum product quantity - base type: decimal, min inclusive: 0, fraction digits: 2, (XPath FASCatalog/FCbody/FCgroup/FCitem/allowanceCharge/@minQty) [Optional] (a) - nota: <i>minimum quantity of product for the application of this allowance or charge</i> (XPath FASCatalog/FCbody/FCgroup/FCitem/marketPrice/allowanceCharge/@minQty) [Optional] - nota: <i>minimum quantity of product for the application of this allowance or charge</i> (XPath FASCatalog/FCbody/FCgroup/FCitem/marketPrice/catalogPrice/@minQty) [Optional] - nota: <i>minimum quantity of product for the application of this price</i> (XPath FASCatalog/FCbody/FCgroup/allowanceCharge/@minQty) [Optional] (a) - nota: <i>minimum quantity of product for the application of this allowance or charge</i> (XPath FASCatalog/terms/allowanceCharge/@minQty) [Optional] (a) - nota: <i>minimum quantity of product for the application of this allowance or charge</i></p>
mod	<p>model number of the garment - base type: string, max length: 15, (XPath FASCatalog/FCbody/FCgroup/FCitem/fashionProd/garmentCode/garmentCodeB/mod) 1-1 (XPath FASCatalog/FCbody/FCgroup/FCitem/fashionProd/garmentPartCode/mod) 1-1 - note: <i>when a garment component, it should be the code assigned to the garment article</i></p>
msgCurrency	<p>currency used to express the monetary amounts of the message - base type: string, cod. table: T9 <a href="http://www.ebiz.enea.it/moda-ml/repository/codelist/v2018-1/gc_T9.xml">http://www.ebiz.enea.it/moda-ml/repository/codelist/v2018-1/gc_T9.xml</a> (XPath FASCatalog/FCheader/msgCurrency) 0-1</p>
msgDate	<p>date of issue of the present message (xml document), according to one of the patterns YYYY-MM-DD, YYYY-MM-DD:HH-MM or YYYY-WW. - base type: string, (XPath FASCatalog/FCheader/msgDate) 1-1</p>
msgID	<p>key identifier of the business document in the information system of the issuing Party. In case of more despatches of the same business document, it is unchanged. - base type: string, max length: 35, (XPath FASCatalog/FCheader/msgID) 0-1</p>
msgN	<p>identification number given to the message (xml document) by its issuer. In case of more despatches of the same business document, it changes. - base type: string, max length: 35, (XPath FASCatalog/FCheader/msgN) 1-1</p>

netWeight	<p>the net weight declared for transport or customs purpose</p> <ul style="list-style-type: none"> <li>- base type: decimal, min inclusive: 0, fraction digits: 2, (XPath FASCatalog/terms/transInfo/netWeight) 0-1</li> <li>(XPath FASCatalog/FCbody/FCgroup/FCitem/packages/handlingChar/netWeight) 0-1</li> </ul>
nominalHeight	<p>nominal height of a specified object</p> <ul style="list-style-type: none"> <li>- base type: decimal, min inclusive: 0, fraction digits: 2, (XPath FASCatalog/FCbody/FCgroup/picture/nominalHeight) 0-2 (N*)</li> <li>- note: <i>Only one instance of this element for each different value of 'um' attribute (unit of measure)</i> (XPath FASCatalog/FCheader/picture/nominalHeight) 0-2 (N*)</li> <li>- note: <i>Only one instance of this element for each different value of 'um' attribute (unit of measure)</i> (XPath FASCatalog/FCbody/FCgroup/FCitem/picture/nominalHeight) 0-2 (N*)</li> <li>- note: <i>Only one instance of this element for each different value of 'um' attribute (unit of measure)</i></li> </ul>
nominalWidth	<p>nominal width of a specified object</p> <ul style="list-style-type: none"> <li>- base type: decimal, min inclusive: 0, fraction digits: 2, (XPath FASCatalog/FCheader/picture/nominalWidth) 0-2 (N*)</li> <li>- note: <i>Only one instance of this element for each different value of 'um' attribute (unit of measure)</i> (XPath FASCatalog/FCbody/FCgroup/FCitem/picture/nominalWidth) 0-2 (N*)</li> <li>- note: <i>Only one instance of this element for each different value of 'um' attribute (unit of measure)</i> (XPath FASCatalog/FCbody/FCgroup/picture/nominalWidth) 0-2 (N*)</li> <li>- note: <i>Only one instance of this element for each different value of 'um' attribute (unit of measure)</i></li> </ul>
note	<p>free text or structured (computer processing) note. For note structuring use the attributes "noteLabel" and "codelist"</p> <ul style="list-style-type: none"> <li>- base type: string, max length: 350, (XPath FASCatalog/FCheader/picture/note) 0-99</li> <li>(XPath FASCatalog/FCbody/FCgroup/FCitem/garmentCategory/note) 0-99</li> <li>(XPath FASCatalog/FCbody/FCgroup/FCitem/allowanceCharge/dtScheme/note) 0-99</li> <li>(XPath FASCatalog/FCbody/FCgroup/FCitem/picture/note) 0-99</li> <li>(XPath FASCatalog/FCheader/note) 0-99</li> <li>(XPath FASCatalog/FCbody/FCgroup/allowanceCharge/dtScheme/note) 0-99</li> <li>(XPath FASCatalog/FCbody/FCgroup/FCitem/packages/handlingChar/note) 0-99</li> <li>(XPath FASCatalog/FCbody/FCgroup/FCitem/fashionProd/note) 0-unbounded</li> <li>(XPath FASCatalog/FCbody/FCgroup/note) 0-99</li> <li>(XPath FASCatalog/garComInfo/note) 0-99</li> <li>(XPath FASCatalog/FCbody/FCgroup/picture/note) 0-99</li> <li>(XPath FASCatalog/terms/allowanceCharge/dtScheme/note) 0-99</li> <li>(XPath FASCatalog/FCbody/FCgroup/FCitem/note) 0-99</li> <li>(XPath FASCatalog/FCbody/FCgroup/FCitem/dtScheme/note) 0-99</li> <li>(XPath FASCatalog/FCbody/FCgroup/garComInfo/note) 0-99</li> <li>(XPath FASCatalog/FCbody/FCgroup/FCitem/marketPrice/allowanceCharge/dtScheme/note) 0-99</li> <li>(XPath FASCatalog/FCbody/FCgroup/FCitem/garComInfo/note) 0-99</li> </ul>
@noteLabel	<p>subject qualifier of a note</p> <ul style="list-style-type: none"> <li>- base type: string, max length: 35, (XPath FASCatalog/terms/allowanceCharge/dtScheme/note/@noteLabel) [Optional]</li> <li>- nota: <i>must be used to qualify the subject of the note</i> (XPath FASCatalog/FCbody/FCgroup/garComInfo/note/@noteLabel) [Optional]</li> <li>- nota: <i>must be used to qualify the subject of the note</i> (XPath FASCatalog/FCheader/picture/note/@noteLabel) [Optional]</li> <li>- nota: <i>must be used to qualify the subject of the note</i> (XPath FASCatalog/FCbody/FCgroup/FCitem/note/@noteLabel) [Optional]</li> <li>- nota: <i>must be used to qualify the subject of the note</i> (XPath FASCatalog/FCbody/FCgroup/FCitem/packages/handlingChar/note/@noteLabel) [Optional]</li> </ul>

	<ul style="list-style-type: none"> <li>- nota: <i>must be used to qualify the subject of the note</i> (XPath FASCatalog/FCbody/FCgroup/FCitem/dtScheme/note/@noteLabel) [Optional]</li> <li>- nota: <i>must be used to qualify the subject of the note</i> (XPath FASCatalog/garComInfo/note/@noteLabel) [Optional]</li> <li>- nota: <i>must be used to qualify the subject of the note</i> (XPath FASCatalog/FCbody/FCgroup/FCitem/fashionProd/note/@noteLabel) [Optional]</li> <li>- nota: <i>must be used to qualify the subject of the note</i> (XPath FASCatalog/FCheader/note/@noteLabel) [Optional]</li> <li>- nota: <i>must be used to qualify the subject of the note</i> (XPath FASCatalog/FCbody/FCgroup/note/@noteLabel) [Optional]</li> <li>- nota: <i>must be used to qualify the subject of the note</i> (XPath FASCatalog/FCbody/FCgroup/FCitem/picture/note/@noteLabel) [Optional]</li> <li>- nota: <i>must be used to qualify the subject of the note</i> (XPath FASCatalog/FCbody/FCgroup/FCitem/marketPrice/allowanceCharge/dtScheme/note/@noteLabel) [Optional]</li> <li>- nota: <i>must be used to qualify the subject of the note</i> (XPath FASCatalog/FCbody/FCgroup/picture/note/@noteLabel) [Optional]</li> <li>- nota: <i>must be used to qualify the subject of the note</i> (XPath FASCatalog/FCbody/FCgroup/FCitem/allowanceCharge/dtScheme/note/@noteLabel) [Optional]</li> <li>- nota: <i>must be used to qualify the subject of the note</i> (XPath FASCatalog/FCbody/FCgroup/allowanceCharge/dtScheme/note/@noteLabel) [Optional]</li> <li>- nota: <i>must be used to qualify the subject of the note</i> (XPath FASCatalog/FCbody/FCgroup/FCitem/garComInfo/note/@noteLabel) [Optional]</li> <li>- nota: <i>must be used to qualify the subject of the note</i> (XPath FASCatalog/FCbody/FCgroup/FCitem/garmentCategory/note/@noteLabel) [Optional]</li> <li>- nota: <i>must be used to qualify the subject of the note</i></li> </ul>
@numberingOrg	<p>code specifying the organisation who has created or owns the coding or numbering system</p> <ul style="list-style-type: none"> <li>- base type: string, cod. table: NT6 <a href="http://www.ebiz.enea.it/moda-ml/repository/codelist/v2018-1/gc_NT6.xml">http://www.ebiz.enea.it/moda-ml/repository/codelist/v2018-1/gc_NT6.xml</a></li> <li>(XPath FASCatalog/FCbody/FCgroup/FCitem/fashionProd/csRange/@numberingOrg) [Optional]</li> <li>(XPath FASCatalog/FCbody/FCgroup/FCitem/garComInfo/operationalCode/@numberingOrg) [Optional]</li> <li>- nota: <i>this attribute should be used either single or coupled with "listName" and "listVersion"</i> (XPath FASCatalog/FCbody/FCgroup/FCitem/fashionProd/csRange/color/@numberingOrg) [Optional]</li> <li>- nota: <i>this attribute should be used either single or coupled with "listName" and "listVersion"</i> (XPath FASCatalog/FCbody/FCgroup/note/@numberingOrg) [Optional]</li> <li>- nota: <i>must be used to specify the organization that created the list of codes used in "noteLabel"</i> (XPath FASCatalog/FCbody/FCgroup/FCitem/fashionProd/garmentCode/garmentCodeA/art/@numberingOrg) [Optional]</li> <li>- nota: <i>this attribute should be used either single or coupled with "listName" and "listVersion"</i> (XPath FASCatalog/FCbody/FCgroup/FCitem/marketPrice/allowanceCharge/dtScheme/note/@numberingOrg) [Optional]</li> <li>- nota: <i>must be used to specify the organization that created the list of codes used in "noteLabel"</i> (XPath FASCatalog/FCbody/FCgroup/FCitem/measureConversion/unitOfSourceMeasure/@numberingOrg) [Optional] [Default= EB]</li> <li>(XPath FASCatalog/FCbody/FCgroup/FCitem/packages/packageModelCode/@numberingOrg) [Optional]</li> <li>(XPath FASCatalog/FCbody/FCgroup/FCitem/measureConversion/unitOfTargetMeasure/@numberingOrg) [Optional] [Default= EB]</li> <li>(XPath FASCatalog/FCheader/refDoc/season/@numberingOrg) [Optional] (a)</li> </ul>



- nota: *this attribute should be used either single or coupled with "listName" and "listVersion"*  
(XPath FASCatalog/FCbody/FCgroup/FCitem/fashionProd/note/@numberingOrg) [Optional]

- nota: *must be used to specify the organization that created the list of codes used in "noteLabel"*  
(XPath FASCatalog/FCbody/FCgroup/FCitem/unitOfMeasure/@numberingOrg) [Optional] [Default= EB] (a)  
(XPath FASCatalog/FCbody/FCgroup/FCitem/garComInfo/note/@numberingOrg) [Optional]

- nota: *must be used to specify the organization that created the list of codes used in "noteLabel"*  
(XPath FASCatalog/FCbody/FCgroup/FCitem/marketPrice/allowanceCharge/dtScheme/legalRef/@numberingOrg) [Optional] (a)

- nota: *this attribute should be used either single or coupled with "listName" and "listVersion"*  
(XPath FASCatalog/FCbody/FCgroup/FCitem/packages/packageN/@numberingOrg) [Optional]  
(XPath FASCatalog/FCbody/FCgroup/FCitem/packages/EPClist/EPC/@numberingOrg) [Optional]  
(XPath FASCatalog/FCbody/FCgroup/FCitem/packages/handlingChar/note/@numberingOrg) [Optional]

- nota: *must be used to specify the organization that created the list of codes used in "noteLabel"*  
(XPath FASCatalog/FCbody/FCgroup/FCitem/packages/handlingChar/garPack/garPackCode/@numberingOrg) [Optional] (a)

- nota: *this attribute should be used either single or coupled with "listName" and "listVersion"*  
(XPath FASCatalog/FCbody/FCgroup/FCitem/garComInfo/garPack/garPackCode/@numberingOrg) [Optional] (a)

- nota: *this attribute should be used either single or coupled with "listName" and "listVersion"*  
(XPath FASCatalog/FCheader/refDoc/attachment/fileName/@numberingOrg) [Optional] (a)  
(XPath FASCatalog/FCbody/FCgroup/FCitem/packages/handlingChar/acsPack/acsPackCode/@numberingOrg) [Optional] (a)

- nota: *this attribute should be used either single or coupled with "listName" and "listVersion"*  
(XPath FASCatalog/FCbody/FCgroup/FCitem/garComInfo/acsPack/acsPackCode/@numberingOrg) [Optional] (a)

- nota: *this attribute should be used either single or coupled with "listName" and "listVersion"*  
(XPath FASCatalog/FCheader/refDoc/docID/@numberingOrg) [Optional]

- nota: *here can be specified whose document numbering is used (e.g.: Client, Supplier, ..)*  
(XPath FASCatalog/FCbody/FCgroup/FCitem/fashionProd/csRange/garmentVariant/variantCode/@numberingOrg) [Optional] (a)

- nota: *this attribute should be used either single or coupled with "listName" and "listVersion"*  
(XPath FASCatalog/FCbody/FCgroup/FCitem/garComInfo/season/@numberingOrg) [Optional] (a)

- nota: *this attribute should be used either single or coupled with "listName" and "listVersion"*  
(XPath FASCatalog/FCbody/FCgroup/FCitem/fashionProd/csRange/drop/@numberingOrg) [Optional] (a)

- nota: *this attribute should be used either single or coupled with "listName" and "listVersion"*  
(XPath FASCatalog/FCbody/FCgroup/FCitem/note/@numberingOrg) [Optional]

- nota: *must be used to specify the organization that created the list of codes used in "noteLabel"*  
(XPath FASCatalog/FCbody/FCgroup/FCitem/garComInfo/productLine/@numberingOrg) [Optional]

- nota: *this attribute should be used either single or coupled with "listName" and "listVersion"*

(XPath FASCatalog/FCbody/FCgroup/FCitem/garComInfo/brand/@numberingOrg) [Optional] (a)  
- nota: *this attribute should be used either single or coupled with "listName" and "listVersion"*

(XPath FASCatalog/FCbody/FCgroup/FCitem/fashionProd/csRange/garmentVariant/variantType/@numberingOrg) [Optional] (a)  
- nota: *this attribute should be used either single or coupled with "listName" and "listVersion"*

(XPath FASCatalog/FCbody/FCgroup/FCitem/dtScheme/note/@numberingOrg) [Optional]  
- nota: *must be used to specify the organization that created the list of codes used in "noteLabel"*

(XPath FASCatalog/FCbody/FCgroup/FCitem/fashionProd/csRange/sizeMatrix/sizeRow/itemsList/qualityLevel/@numberingOrg) [Optional] (a)  
- nota: *this attribute should be used either single or coupled with "listName" and "listVersion"*

(XPath FASCatalog/FCbody/FCgroup/FCitem/dtScheme/legalRef/@numberingOrg) [Optional] (a)  
- nota: *this attribute should be used either single or coupled with "listName" and "listVersion"*

(XPath FASCatalog/FCbody/FCgroup/FCitem/fashionProd/csRange/sizeMatrix/sizeRow/itemsList/itemIdentification/serialN/@numberingOrg) [Optional]  
- nota: *here the issuer of the serial number must be specified (when different from the Supplier)*

(XPath FASCatalog/FCbody/FCgroup/FCitem/allowanceCharge/dtScheme/legalRef/@numberingOrg) [Optional] (a)  
- nota: *this attribute should be used either single or coupled with "listName" and "listVersion"*

(XPath FASCatalog/FCbody/FCgroup/FCitem/fashionProd/csRange/sizeMatrix/sizeRow/drop/@numberingOrg) [Optional] (a)  
- nota: *this attribute should be used either single or coupled with "listName" and "listVersion"*

(XPath FASCatalog/FCbody/FCgroup/FCitem/fashionProd/csRange/sizeMatrix/sizeRow/additionalComponentCode/@numberingOrg) [Optional] (a)  
- nota: *this attribute should be used either single or coupled with "listName" and "listVersion"*

(XPath FASCatalog/FCbody/FCgroup/FCitem/fashionProd/csRange/sizeMatrix/sizeRow/size/@numberingOrg) [Optional] (a)  
- nota: *this attribute should be used either single or coupled with "listName" and "listVersion"*

(XPath FASCatalog/FCbody/FCgroup/FCitem/allowanceCharge/dtScheme/note/@numberingOrg) [Optional]  
- nota: *must be used to specify the organization that created the list of codes used in "noteLabel"*

(XPath FASCatalog/FCbody/FCgroup/FCitem/productLine/@numberingOrg) [Optional] (a)  
- nota: *this attribute should be used either single or coupled with "listName" and "listVersion"*

(XPath FASCatalog/FCbody/FCgroup/FCitem/brand/@numberingOrg) [Optional] (a)  
- nota: *this attribute should be used either single or coupled with "listName" and "listVersion"*

(XPath FASCatalog/FCbody/FCgroup/refDoc/attachment/fileName/@numberingOrg) [Optional]  
(XPath FASCatalog/FCbody/FCgroup/FCitem/garmentCategory/artGroup/@numberingOrg) [Optional]  
- nota: *this attribute should be used either single or coupled with "listName" and "listVersion"*

(XPath FASCatalog/FCbody/FCgroup/FCitem/garmentCategory/@numberingOrg) [Optional]  
(XPath FASCatalog/FCbody/FCgroup/FCitem/operationalCode/@numberingOrg) [Optional] (a)

- nota: *this attribute should be used either single or coupled with "listName" and "listVersion"*  
(XPath FASCatalog/FCbody/FCgroup/FCitem/picture/note/@numberingOrg) [Optional] (a)

- nota: *must be used to specify the organization that created the list of codes used in "noteLabel"*  
(XPath FASCatalog/garComInfo/season/@numberingOrg) [Optional] (a)

- nota: *this attribute should be used either single or coupled with "listName" and "listVersion"*  
(XPath FASCatalog/garComInfo/brand/@numberingOrg) [Optional] (a)

- nota: *this attribute should be used either single or coupled with "listName" and "listVersion"*  
(XPath FASCatalog/garComInfo/productLine/@numberingOrg) [Optional] (a)

- nota: *this attribute should be used either single or coupled with "listName" and "listVersion"*  
(XPath FASCatalog/FCbody/FCgroup/FCitem/picture/attachment/fileName/@numberingOrg) [Optional] (a)

(XPath FASCatalog/terms/allowanceCharge/dtScheme/legalRef/@numberingOrg) [Optional] (a)

- nota: *this attribute should be used either single or coupled with "listName" and "listVersion"*  
(XPath FASCatalog/terms/allowanceCharge/dtScheme/note/@numberingOrg) [Optional]

- nota: *must be used to specify the organization that created the list of codes used in "noteLabel"*  
(XPath FASCatalog/FCbody/FCgroup/FCitem/fashionProd/yarnCode/@numberingOrg) [Optional] [Default= CL]

(XPath FASCatalog/FCbody/FCgroup/FCitem/fashionProd/additionalComponentCode/@numberingOrg) [Optional]

- nota: *this attribute should be used either single or coupled with "listName" and "listVersion"*  
(XPath FASCatalog/FCheader/season/@numberingOrg) [Optional] (a)

- nota: *this attribute should be used either single or coupled with "listName" and "listVersion"*  
(XPath FASCatalog/FCheader/picture/note/@numberingOrg) [Optional]

- nota: *must be used to specify the organization that created the list of codes used in "noteLabel"*  
(XPath FASCatalog/FCbody/FCgroup/FCitem/fashionProd/yarnCode/color/@numberingOrg) [Optional]

- nota: *this attribute should be used either single or coupled with "listName" and "listVersion"*  
(XPath FASCatalog/FCbody/FCgroup/FCitem/fashionProd/yarnCode/art/@numberingOrg) [Optional]

- nota: *this attribute should be used either single or coupled with "listName" and "listVersion"*  
(XPath FASCatalog/FCbody/FCgroup/FCitem/garmentCategory/note/@numberingOrg) [Optional]

- nota: *must be used to specify the organization that created the list of codes used in "noteLabel"*  
(XPath FASCatalog/FCbody/FCgroup/FCitem/garmentCategory/season/@numberingOrg) [Optional]

- nota: *this attribute should be used either single or coupled with "listName" and "listVersion"*  
(XPath FASCatalog/FCbody/FCgroup/FCitem/garmentCategory/artSex/@numberingOrg) [Optional]

- nota: *this attribute should be used either single or coupled with "listName" and "listVersion"*  
(XPath FASCatalog/FCbody/FCgroup/FCitem/garmentCategory/artSubGroup/@numberingOrg) [Optional]

- nota: *this attribute should be used either single or coupled with "listName" and "listVersion"*  
(XPath FASCatalog/FCbody/FCgroup/FCitem/garmentCategory/goodsClassification/subClass/@numberingOrg) [Optional] (a)

- nota: *this attribute should be used either single or coupled with "listName" and "listVersion"*  
 (XPath FASCatalog/FCbody/FCgroup/FCitem/garmentCategory/goodsClassification/class/@numberingOrg) [Optional] (a)

- nota: *this attribute should be used either single or coupled with "listName" and "listVersion"*  
 (XPath FASCatalog/FCbody/FCgroup/FCitem/garmentCategory/goodsClassification/macroClass/@numberingOrg) [Optional] (a)

- nota: *this attribute should be used either single or coupled with "listName" and "listVersion"*  
 (XPath FASCatalog/FCbody/FCgroup/garComInfo/brand/@numberingOrg) [Optional] (a)

- nota: *this attribute should be used either single or coupled with "listName" and "listVersion"*  
 (XPath FASCatalog/garComInfo/garPack/garPackCode/@numberingOrg) [Optional] (a)

- nota: *this attribute should be used either single or coupled with "listName" and "listVersion"*  
 (XPath FASCatalog/FCbody/FCgroup/garComInfo/season/@numberingOrg) [Optional] (a)

- nota: *this attribute should be used either single or coupled with "listName" and "listVersion"*  
 (XPath FASCatalog/FCbody/FCgroup/garComInfo/operationalCode/@numberingOrg) [Optional] (a)

- nota: *this attribute should be used either single or coupled with "listName" and "listVersion"*  
 (XPath FASCatalog/garComInfo/acsPack/acsPackCode/@numberingOrg) [Optional] (a)

- nota: *this attribute should be used either single or coupled with "listName" and "listVersion"*  
 (XPath FASCatalog/FCbody/FCgroup/garComInfo/productLine/@numberingOrg) [Optional] (a)

- nota: *this attribute should be used either single or coupled with "listName" and "listVersion"*  
 (XPath FASCatalog/FCbody/FCgroup/allowanceCharge/dtScheme/note/@numberingOrg) [Optional]

- nota: *must be used to specify the organization that created the list of codes used in "noteLabel"*  
 (XPath FASCatalog/garComInfo/note/@numberingOrg) [Optional]

- nota: *must be used to specify the organization that created the list of codes used in "noteLabel"*  
 (XPath FASCatalog/FCbody/FCgroup/picture/note/@numberingOrg) [Optional]

- nota: *must be used to specify the organization that created the list of codes used in "noteLabel"*  
 (XPath FASCatalog/FCbody/FCgroup/picture/attachment/fileName/@numberingOrg) [Optional]

(XPath FASCatalog/FCbody/FCgroup/allowanceCharge/dtScheme/legalRef/@numberingOrg) [Optional] (a)

- nota: *this attribute should be used either single or coupled with "listName" and "listVersion"*  
 (XPath FASCatalog/FCheader/supplier/id/@numberingOrg) [Optional]

(XPath FASCatalog/FCheader/supplier/additionalIdentifier/@numberingOrg) [Optional] (a)

- nota: *here the issuer of the identifier must be specified*  
 (XPath FASCatalog/FCbody/FCgroup/FCitem/refDoc/attachment/fileName/@numberingOrg) [Optional] (a)

(XPath FASCatalog/FCbody/FCgroup/refDoc/season/@numberingOrg) [Optional] (a)

- nota: *this attribute should be used either single or coupled with "listName" and "listVersion"*  
 (XPath FASCatalog/FCbody/FCgroup/FCitem/refDoc/season/@numberingOrg) [Optional] (a)

- nota: *this attribute should be used either single or coupled with "listName" and "listVersion"*  
(XPath FASCatalog/garComInfo/operationalCode/@numberingOrg) [Optional] (a)

- nota: *this attribute should be used either single or coupled with "listName" and "listVersion"*  
(XPath FASCatalog/FCheader/buyer/id/@numberingOrg) [Optional]  
(XPath FASCatalog/FCheader/buyer/additionalIdentifier/@numberingOrg) [Optional] (a)

- nota: *here the issuer of the identifier must be specified*  
(XPath FASCatalog/FCbody/FCgroup/FCitem/refDoc/docID/@numberingOrg) [Optional]

- nota: *here can be specified whose document numbering is used (e.g.: Client, Supplier, ..)*  
(XPath FASCatalog/FCbody/FCgroup/refDoc/docID/@numberingOrg) [Optional]

- nota: *here can be specified whose document numbering is used (e.g.: Client, Supplier, ..)*  
(XPath FASCatalog/FCbody/FCgroup/artGroup/@numberingOrg) [Optional]

- nota: *this attribute should be used either single or coupled with "listName" and "listVersion"*  
(XPath FASCatalog/FCheader/thirdParty/id/@numberingOrg) [Optional]  
(XPath FASCatalog/FCbody/FCgroup/garComInfo/note/@numberingOrg) [Optional]

- nota: *must be used to specify the organization that created the list of codes used in "noteLabel"*  
(XPath FASCatalog/FCbody/FCgroup/garComInfo/garPack/garPackCode/@numberingOrg) [Optional]

- nota: *this attribute should be used either single or coupled with "listName" and "listVersion"*  
(XPath FASCatalog/FCbody/FCgroup/garComInfo/acsPack/acsPackCode/@numberingOrg) [Optional]

- nota: *this attribute should be used either single or coupled with "listName" and "listVersion"*  
(XPath FASCatalog/FCbody/FCgroup/FCitem/fashionProd/garmentPartCode/color/@numberingOrg) [Optional]

- nota: *this attribute should be used either single or coupled with "listName" and "listVersion"*  
(XPath FASCatalog/FCbody/FCgroup/FCitem/fashionProd/acsCode/pattern/@numberingOrg) [Optional]

- nota: *this attribute should be used either single or coupled with "listName" and "listVersion"*  
(XPath FASCatalog/FCbody/FCgroup/FCitem/fashionProd/garmentCode/garmentCodeB/size/@numberingOrg) [Optional] (a)

- nota: *this attribute should be used either single or coupled with "listName" and "listVersion"*  
(XPath FASCatalog/FCbody/FCgroup/FCitem/fashionProd/garmentPartCode/added/@numberingOrg) [Optional]

- nota: *this attribute should be used either single or coupled with "listName" and "listVersion"*  
(XPath FASCatalog/FCbody/FCgroup/FCitem/fashionProd/acsCode/@numberingOrg) [Optional]  
(XPath FASCatalog/FCbody/FCgroup/FCitem/fashionProd/acsCode/art/@numberingOrg) [Optional]

- nota: *this attribute should be used either single or coupled with "listName" and "listVersion"*  
(XPath FASCatalog/FCheader/picture/attachment/fileName/@numberingOrg) [Optional] (a)

(XPath FASCatalog/FCbody/FCgroup/FCitem/fashionProd/garmentCode/garmentCodeB/drop/@numberingOrg) [Optional] (a)

- nota: *this attribute should be used either single or coupled with "listName" and "listVersion"*  
(XPath FASCatalog/FCbody/FCgroup/FCitem/fashionProd/acsCode/added/@numberingOrg) [Optional]

- nota: *this attribute should be used either single or coupled with "listName" and "listVersion"*

(XPath FASCatalog/FCbody/FCgroup/FCitem/fashionProd/garmentPartCode/@numberingOrg) [Optional]

(XPath FASCatalog/FCbody/FCgroup/FCitem/fashionProd/garmentPartCode/mod/@numberingOrg) [Optional]

(XPath FASCatalog/FCbody/FCgroup/FCitem/fashionProd/garmentPartCode/fabric/@numberingOrg) [Optional]

- nota: *this attribute should be used either single or coupled with "listName" and "listVersion"*

(XPath FASCatalog/FCheader/note/@numberingOrg) [Optional]

- nota: *must be used to specify the organization that created the list of code s used in "noteLabel"*

(XPath FASCatalog/FCbody/FCgroup/FCitem/fashionProd/garmentCode/garmentCodeB/garmentVariant/variantCode/@numberingOrg) [Optional] (a)

- nota: *this attribute should be used either single or coupled with "listName" and "listVersion"*

(XPath FASCatalog/FCbody/FCgroup/FCitem/fashionProd/acsCode/color/@numberingOrg) [Optional]

- nota: *this attribute should be used either single or coupled with "listName" and "listVersion"*

(XPath FASCatalog/FCbody/FCgroup/FCitem/fashionProd/garmentCode/garmentCodeB/color/@numberingOrg) [Optional]

- nota: *this attribute should be used either single or coupled with "listName" and "listVersion"*

(XPath FASCatalog/FCbody/FCgroup/FCitem/fashionProd/texCode/art/@numberingOrg) [Optional]

- nota: *this attribute should be used either single or coupled with "listName" and "listVersion"*

(XPath FASCatalog/FCbody/FCgroup/FCitem/fashionProd/garmentCode/garmentCodeB/@numberingOrg) [Optional]

(XPath FASCatalog/FCbody/FCgroup/FCitem/fashionProd/yarnCode/added/@numberingOrg) [Optional]

- nota: *this attribute should be used either single or coupled with "listName" and "listVersion"*

(XPath FASCatalog/FCbody/FCgroup/FCitem/fashionProd/garmentCode/garmentCodeB/mod/@numberingOrg) [Optional]

(XPath FASCatalog/FCbody/FCgroup/FCitem/fashionProd/garmentCode/garmentCodeB/added/@numberingOrg) [Optional]

- nota: *this attribute should be used either single or coupled with "listName" and "listVersion"*

(XPath FASCatalog/FCbody/FCgroup/FCitem/fashionProd/texCode/@numberingOrg) [Optional]

(XPath FASCatalog/FCbody/FCgroup/FCitem/fashionProd/garmentCode/garmentCodeB/fabric/@numberingOrg) [Optional]

- nota: *this attribute should be used either single or coupled with "listName" and "listVersion"*

(XPath FASCatalog/FCbody/FCgroup/FCitem/fashionProd/garmentCode/garmentCodeB/garmentVariant/variantType/@numberingOrg) [Optional] (a)

- nota: *this attribute should be used either single or coupled with "listName" and "listVersion"*

(XPath FASCatalog/FCbody/FCgroup/FCitem/fashionProd/texCode/pattern/@numberingOrg) [Optional]

- nota: *this attribute should be used either single or coupled with "listName" and "listVersion"*

(XPath FASCatalog/FCbody/FCgroup/FCitem/fashionProd/texCode/color/@numberingOrg) [Optional]

- nota: *this attribute should be used either single or coupled with "listName" and "listVersion"*

(XPath FASCatalog/FCbody/FCgroup/FCitem/fashionProd/texCode/added/@numberingOrg) [Optional]

- nota: *this attribute should be used either single or coupled with "listName" and "listVersion"*

(XPath FASCatalog/FCbody/FCgroup/FCitem/fashionProd/garmentPartCode/size/@numberingOrg) [Optional] (a)

	<p>- nota: <i>this attribute should be used either single or coupled with "listName" and "listVersion"</i></p> <p>(XPath FASCatalog/FCbody/FCgroup/FCitem/fashionProd/garmentCode/@numberingOrg) [Optional]</p> <p>(XPath FASCatalog/FCbody/FCgroup/FCitem/fashionProd/garmentCode/garmentCodeB/artGroup/@numberingOrg) [Optional]</p> <p>- nota: <i>this attribute should be used either single or coupled with "listName" and "listVersion"</i></p>
operationalCode	<p>operational code: it is the code of a project, an event, an initiative, a sales channel, a management type (eg CITES), ... the document, or product, is connected with.</p> <p>- base type: string,</p> <p>(XPath FASCatalog/garComInfo/operationalCode) 0-19 (N)</p> <p>(XPath FASCatalog/FCbody/FCgroup/garComInfo/operationalCode) 0-19 (N)</p> <p>(XPath FASCatalog/FCbody/FCgroup/FCitem/operationalCode) 0-19 (N)</p> <p>(XPath FASCatalog/FCbody/FCgroup/FCitem/garComInfo/operationalCode) 0-19 (N)</p>
package	<p>code specifying the type of transport package</p> <p>- base type: string, cod. table: T11</p> <p><a href="http://www.ebiz.enea.it/moda-ml/repository/codelist/v2018-1/gc_T11.xml">http://www.ebiz.enea.it/moda-ml/repository/codelist/v2018-1/gc_T11.xml</a></p> <p>(XPath FASCatalog/FCbody/FCgroup/FCitem/packages/package) 1-1</p>
@packageContainerN	<p>reference usable to indicate the outer package containing this package</p> <p>- base type: string, max length: 40,</p> <p>(XPath FASCatalog/FCbody/FCgroup/FCitem/packages/packageN/@packageContainerN) [Optional]</p>
@packageLevel	<p>level used to indicate the hierarchical structure of the packages (from outer to inner levels)</p> <p>- base type: positiveInteger, min inclusive: 1, max inclusive: 9,</p> <p>(XPath FASCatalog/FCbody/FCgroup/FCitem/packages/@packageLevel) [Optional]</p> <p>- nota: <i>number fixing the level of the package in the transport structure (from inner to outer). Must either be used for all package types or not be used</i></p>
packageModelCode	<p>a code (eg a barcode) identifying the type of packaging</p> <p>- base type: string,</p> <p>(XPath FASCatalog/FCbody/FCgroup/FCitem/packages/packageModelCode) 0-1 (N)</p>
packageN	<p>serial number used to identify a transport package</p> <p>- base type: string, max length: 40,</p> <p>(XPath FASCatalog/FCbody/FCgroup/FCitem/packages/packageN) 0-unbounded (U)</p> <p>- note: <i>here the serial no.s of the packages can be identified</i></p>
packageQty	<p>quantity of the specified transport packages</p> <p>- base type: positiveInteger,</p> <p>(XPath FASCatalog/FCbody/FCgroup/FCitem/packages/packageQty) 0-1</p> <p>- note: <i>total for the type of package</i></p>
packageText	<p>denomination of the type of transport package (text)</p> <p>- base type: string, max length: 80,</p> <p>(XPath FASCatalog/FCbody/FCgroup/FCitem/packages/packageText) 1-1 (U)</p>
@part	<p>percent fraction of a total payment</p> <p>- base type: decimal, min inclusive: 1, max inclusive: 99, fraction digits: 2,</p> <p>(XPath FASCatalog/terms/insPayment/@part) [Required]</p> <p>- nota: <i>here the % value of each installment must be indicated</i></p>
pattern	<p>pattern/design number of the product, when not included in the article code</p> <p>- base type: string, max length: 15,</p> <p>(XPath FASCatalog/FCbody/FCgroup/FCitem/fashionProd/acsCode/pattern) 0-1</p>

	(XPath FASCatalog/FCbody/FCgroup/FCitem/fashionProd/ texCode/pattern) 0-1
payMode	way or means of payment - base type: string, cod. table: T2 <a href="http://www.ebiz.enea.it/moda-ml/repository/codelist/v2018-1/gc_T2.xml">http://www.ebiz.enea.it/moda-ml/repository/codelist/v2018-1/gc_T2.xml</a> (XPath FASCatalog/terms/payment/payMode) 0-1 (XPath FASCatalog/terms/insPayment/payMode) 0-1
payTerm	code specifying the terms or time by which the payment must be done - base type: string, cod. table: T1 <a href="http://www.ebiz.enea.it/moda-ml/repository/codelist/v2018-1/gc_T1.xml">http://www.ebiz.enea.it/moda-ml/repository/codelist/v2018-1/gc_T1.xml</a> (XPath FASCatalog/terms/payment/payTerm) 1-1 (XPath FASCatalog/terms/insPayment/payTerm) 1-1
payTermText	free text specifying the terms by which the payment must be done (time/mo de or means) - base type: string, max length: 250, (XPath FASCatalog/terms/payment/payTermText) 1-1 (U) (XPath FASCatalog/terms/insPayment/payTermText) 1-1 (U)
percCompos	fiber rate in the product composition - base type: decimal, min inclusive: 0, max inclusive: 100, fraction digits: 2, (XPath FASCatalog/FCbody/FCgroup/FCitem/composition/ garmentCompos/percCompos) 1-99
person	name of the contact person within a Party - base type: string, max length: 40, (XPath FASCatalog/FCheader/thirdParty/person) 0-1 (XPath FASCatalog/FCheader/buyer/person) 0-1 (XPath FASCatalog/FCheader/supplier/person) 0-1
@phone	phone number of the contact person within a Party - base type: string, max length: 35, (XPath FASCatalog/FCheader/supplier/person/@phone) [Optional] (XPath FASCatalog/FCheader/buyer/person/@phone) [Optional] (XPath FASCatalog/FCheader/thirdParty/person/@phone) [Optional]
pictureCode	picture code (it might be shared among more files) - base type: string, max length: 80, (XPath FASCatalog/FCbody/FCgroup/picture/pictureCode) 0-1 (N*) (XPath FASCatalog/FCheader/picture/pictureCode) 0-1 (N*) (XPath FASCatalog/FCbody/FCgroup/FCitem/picture/pictureCode) 0-1 (N*)
pictureQualifier	qualifies the image from the business point of view (i.e. main image, detail i mage,...) - base type: string, (XPath FASCatalog/FCheader/picture/pictureQualifier) 0-1 (N*) (XPath FASCatalog/FCbody/FCgroup/picture/pictureQualifier) 0-1 (N*) (XPath FASCatalog/FCbody/FCgroup/FCitem/picture/pictureQualifier) 0-1 (N*)
pictureUse	picture final use - base type: string, cod. table: NT72 <a href="http://www.ebiz.enea.it/moda-ml/repository/codelist/v2018-1/gc_NT72.xml">http://www.ebiz.enea.it/moda-ml/repository/codelist/v2018-1/gc_NT72.xml</a> (XPath FASCatalog/FCbody/FCgroup/picture/pictureUse) 0-1 (N*) (XPath FASCatalog/FCheader/picture/pictureUse) 0-1 (N*) (XPath FASCatalog/FCbody/FCgroup/FCitem/picture/pictureUse) 0-1 (N*)
piecelnnWrap1	code specifying the type of inner wrapping/packing used for the fabric piece - base type: string, cod. table: T4 <a href="http://www.ebiz.enea.it/moda-ml/repository/codelist/v2018-1/gc_T4.xml">http://www.ebiz.enea.it/moda-ml/repository/codelist/v2018-1/gc_T4.xml</a> (XPath FASCatalog/FCbody/FCgroup/garComInfo/piecePack/piecelnnWrap1) 1-1 (XPath FASCatalog/garComInfo/piecePack/piecelnnWrap1) 1-1 (XPath FASCatalog/FCbody/FCgroup/FCitem/packages/ handlingChar/piecePack/piecelnnWrap1) 1-1 (XPath FASCatalog/FCbody/FCgroup/FCitem/garComInfo/ piecePack/piecelnnWrap1) 1-1



pieceInnWrap2	code sub-specifying the type of inner wrapping/packing used for the fabric piece - base type: string, cod. table: T5 <a href="http://www.ebiz.enea.it/moda-ml/repository/codelist/v2018-1/gc_T5.xml">http://www.ebiz.enea.it/moda-ml/repository/codelist/v2018-1/gc_T5.xml</a> (XPath FASCatalog/FCbody/FCgroup/FCitem/garComInfo/piecePack/pieceInnWrap2) 0-1 (XPath FASCatalog/FCbody/FCgroup/FCitem/packages/handlingChar/piecePack/pieceInnWrap2) 0-1 (XPath FASCatalog/FCbody/FCgroup/garComInfo/piecePack/pieceInnWrap2) 0-1 (XPath FASCatalog/garComInfo/piecePack/pieceInnWrap2) 0-1
pieceOutWrap	code specifying the type of outer wrapping or packing used for the fabric piece - base type: string, cod. table: T6 <a href="http://www.ebiz.enea.it/moda-ml/repository/codelist/v2018-1/gc_T6.xml">http://www.ebiz.enea.it/moda-ml/repository/codelist/v2018-1/gc_T6.xml</a> (XPath FASCatalog/FCbody/FCgroup/FCitem/packages/handlingChar/piecePack/pieceOutWrap) 0-1 (XPath FASCatalog/FCbody/FCgroup/garComInfo/piecePack/pieceOutWrap) 0-1 (XPath FASCatalog/garComInfo/piecePack/pieceOutWrap) 0-1 (XPath FASCatalog/FCbody/FCgroup/FCitem/garComInfo/piecePack/pieceOutWrap) 0-1
piecePackText	free text specifying the type of wrapping or packing used for the fabric piece - base type: string, max length: 250, (XPath FASCatalog/FCbody/FCgroup/FCitem/packages/handlingChar/piecePack/piecePackText) 1-1 (U) (XPath FASCatalog/garComInfo/piecePack/piecePackText) 1-1 (U) (XPath FASCatalog/FCbody/FCgroup/garComInfo/piecePack/piecePackText) 1-1 (U) (XPath FASCatalog/FCbody/FCgroup/FCitem/garComInfo/piecePack/piecePackText) 1-1 (U)
postCode	code defining the postal zone - base type: string, max length: 10, (XPath FASCatalog/FCheader/supplier/postCode) 0-1 (XPath FASCatalog/FCheader/thirdParty/postCode) 0-1 (XPath FASCatalog/FCheader/buyer/postCode) 0-1
prodServName	description of the product or service that either complements or substitutes its coding - base type: string, max length: 100, (XPath FASCatalog/FCbody/FCgroup/FCitem/prodServName) 0-1 (U)
productLine	the product line name of a fashion product. - base type: string, (XPath FASCatalog/FCbody/FCgroup/FCitem/productLine) 0-1 (N) (XPath FASCatalog/FCbody/FCgroup/garComInfo/productLine) 0-1 (N) (XPath FASCatalog/garComInfo/productLine) 0-1 (N) (XPath FASCatalog/FCbody/FCgroup/FCitem/garComInfo/productLine) 0-1 (N)
@progr	progressive number in the sequence - base type: positiveInteger, min inclusive: 1, (XPath FASCatalog/terms/transInfo/@progr) [Optional] (N) - nota: <i>Indicates the position of the leg in a sequence of transport legs. If it is declared it must be in all the transInfo elements.</i> (XPath FASCatalog/FCbody/FCgroup/FCitem/packages/fillingCriterion/@progr) [Optional] (N)
project	code used to assign the items ordered (fabric pieces, accessories, garments ...) to a specific project of the Client - base type: string, max length: 40, (XPath FASCatalog/FCbody/FCgroup/FCitem/garComInfo/project) 0-1 (U) (XPath FASCatalog/FCbody/FCgroup/garComInfo/project) 0-1 (U) (XPath FASCatalog/garComInfo/project) 0-1 (U)

qty	net quantity of the article or object correlated, qualified by the function of the document (ordering, delivering, ..) and by the context - base type: decimal, min inclusive: 0, fraction digits: 2, (XPath FASCatalog/FCbody/FCgroup/FCitem/fashionProd/csRange/sizeMatrix/sizeRow/qty) 0-1
qualityLevel	the product quality level (first choice, second choice,...). - base type: string, (XPath FASCatalog/FCbody/FCgroup/FCitem/fashionProd/csRange/sizeMatrix/sizeRow/itemsList/qualityLevel) 0-1 (N)
@reelMat	type of material of which a package for yarn is made - base type: string, cod. table: T30 <a href="http://www.ebiz.enea.it/moda-ml/repository/codelist/v2018-1/gc_T30.xml">http://www.ebiz.enea.it/moda-ml/repository/codelist/v2018-1/gc_T30.xml</a> (XPath FASCatalog/FCbody/FCgroup/garComInfo/yarnPack/yarnReel/@reelMat) [Optional] (XPath FASCatalog/FCbody/FCgroup/FCitem/packages/handlingChar/yarnPack/yarnReel/@reelMat) [Optional] (XPath FASCatalog/garComInfo/yarnPack/yarnReel/@reelMat) [Optional] (XPath FASCatalog/FCbody/FCgroup/FCitem/garComInfo/yarnPack/yarnReel/@reelMat) [Optional]
@reelType	type of package used for a yarn product - base type: string, cod. table: T29 <a href="http://www.ebiz.enea.it/moda-ml/repository/codelist/v2018-1/gc_T29.xml">http://www.ebiz.enea.it/moda-ml/repository/codelist/v2018-1/gc_T29.xml</a> (XPath FASCatalog/FCbody/FCgroup/garComInfo/yarnPack/yarnReel/@reelType) [Required] (XPath FASCatalog/FCbody/FCgroup/FCitem/garComInfo/yarnPack/yarnReel/@reelType) [Required] (XPath FASCatalog/garComInfo/yarnPack/yarnReel/@reelType) [Required] (XPath FASCatalog/FCbody/FCgroup/FCitem/packages/handlingChar/yarnPack/yarnReel/@reelType) [Required]
rendering	rendering information about the image - base type: string, (XPath FASCatalog/FCheader/picture/rendering) 0-1 (N*) (XPath FASCatalog/FCbody/FCgroup/FCitem/picture/rendering) 0-1 (N*) (XPath FASCatalog/FCbody/FCgroup/picture/rendering) 0-1 (N*)
resolution	measure of spatial density of the picture - base type: string, max length: 255, (XPath FASCatalog/FCbody/FCgroup/FCitem/picture/resolution) 0-1 (N*) (XPath FASCatalog/FCheader/picture/resolution) 0-1 (N*) (XPath FASCatalog/FCbody/FCgroup/picture/resolution) 0-1 (N*)
@resolutionType	it indicates the type of density of the picture - base type: string, cod. table: NT71 <a href="http://www.ebiz.enea.it/moda-ml/repository/codelist/v2018-1/gc_NT71.xml">http://www.ebiz.enea.it/moda-ml/repository/codelist/v2018-1/gc_NT71.xml</a> (XPath FASCatalog/FCbody/FCgroup/FCitem/picture/resolution/@resolutionType) [Optional] [Default= dpi] (N) (XPath FASCatalog/FCheader/picture/resolution/@resolutionType) [Optional] [Default= dpi] (Na) (XPath FASCatalog/FCbody/FCgroup/picture/resolution/@resolutionType) [Optional] [Default= dpi] (Na)
@role	Third Party role qualifier - base type: string, cod. table: NT2 <a href="http://www.ebiz.enea.it/moda-ml/repository/codelist/v2018-1/gc_NT2.xml">http://www.ebiz.enea.it/moda-ml/repository/codelist/v2018-1/gc_NT2.xml</a> (XPath FASCatalog/FCheader/thirdParty/@role) [Required]
season	sale season; defined as: season (1 crt) + year (4 crt) - season: S/S=1 A/W=2 Spring=3 Summer=4 Autumn=5 Winter=6: for more than four seasons use alphabetic sequence: 1st season=A 2nd season=B etc.etc. - base type: string, max length: 15, (XPath FASCatalog/garComInfo/season) 0-1 (A) - note: <i>Preferably do not use this element here if season is declared in the header.</i> (XPath FASCatalog/FCbody/FCgroup/garComInfo/season) 0-1 (A)

	<p>- note: Preferably do not use this element here if season is declared in the header. (XPath FASCatalog/FCbody/FCgroup/FCitem/garmentCategory/season) 0-1 (A) (XPath FASCatalog/FCbody/FCgroup/FCitem/garComInfo/season) 0-1 (A)</p> <p>- note: Preferably do not use this element here if season is declared in the header. (XPath FASCatalog/FCbody/FCgroup/FCitem/refDoc/season) 0-1 (A)</p> <p>- note: here indicates the season to which the referenced document belongs (XPath FASCatalog/FCbody/FCgroup/refDoc/season) 0-1 (A)</p> <p>- note: here indicates the season to which the referenced document belongs (XPath FASCatalog/FCheader/season) 0-1 (A) (XPath FASCatalog/FCheader/refDoc/season) 0-1 (A)</p> <p>- note: here indicates the season to which the referenced document belongs</p>
@sender	<p>qualifier that specifies the Party issuing of the document</p> <p>- base type: boolean, (XPath FASCatalog/FCheader/supplier/@sender) [Optional] (a*)</p> <p>- nota: This attribute is mandatory when the STYLESHEET must be used (XPath FASCatalog/FCheader/buyer/@sender) [Optional] (a*)</p> <p>- nota: This attribute is mandatory when the STYLESHEET must be used (XPath FASCatalog/FCheader/thirdParty/@sender) [Optional] (a*)</p> <p>- nota: This attribute is mandatory when the STYLESHEET must be used</p>
serialN	<p>serial number used for the identification of a physical unit</p> <p>- base type: string, max length: 250, (XPath FASCatalog/FCbody/FCgroup/FCitem/fashionProd/csRange/sizeMatrix/sizeRow/itemsList/itemIdentification/serialN) 1-9 (AU)</p> <hr/> <p><b>AAAA-WARNING! - text not AVAILABLE n. 245 - In=en</b></p> <p>- note: multiple values of serialN are allowed for different representations of the serial identifier of the same product unit. Instances of serialN must differ at least for one value of numberingOrg and idQualifier.</p>
size	<p>size number of a fashion product (knitwear, clothing, ..)</p> <p>- base type: string, max length: 15, (XPath FASCatalog/FCbody/FCgroup/FCitem/fashionProd/csRange/sizeMatrix/sizeRow/size) 1-1 (A) (XPath FASCatalog/FCbody/FCgroup/FCitem/fashionProd/garmentPartCode/size) 0-1 (A) (XPath FASCatalog/FCbody/FCgroup/FCitem/fashionProd/garmentCode/garmentCodeB/size) 0-1 (A)</p>
@sizeSystemBase	<p>base of the size system</p> <p>- base type: string, cod. table: T423 <a href="http://www.ebiz.enea.it/moda-ml/repository/codelist/v2018-1/gc_T423.xml">http://www.ebiz.enea.it/moda-ml/repository/codelist/v2018-1/gc_T423.xml</a> (XPath FASCatalog/FCbody/FCgroup/FCitem/fashionProd/csRange/@sizeSystemBase) [Optional]</p>
@sizeSystemID	<p>the identifier of the size system.</p> <p>- base type: string, (XPath FASCatalog/FCbody/FCgroup/FCitem/fashionProd/csRange/@sizeSystemID) [Optional]</p>
@sizeSystemNat	<p>nation or agency identifying the size system</p> <p>- base type: string, cod. table: T421 <a href="http://www.ebiz.enea.it/moda-ml/repository/codelist/v2018-1/gc_T421.xml">http://www.ebiz.enea.it/moda-ml/repository/codelist/v2018-1/gc_T421.xml</a> (XPath FASCatalog/FCbody/FCgroup/FCitem/fashionProd/csRange/@sizeSystemNat) [Optional]</p>
@sizeSystemSeg	<p>market segment identifying the size system</p> <p>- base type: string, cod. table: T422 <a href="http://www.ebiz.enea.it/moda-ml/repository/codelist/v2018-1/gc_T422.xml">http://www.ebiz.enea.it/moda-ml/repository/codelist/v2018-1/gc_T422.xml</a> (XPath FASCatalog/FCbody/FCgroup/FCitem/fashionProd/csRange/@sizeSystemSeg) [Optional]</p>
sortableIndicator	<p>It states if the item can be automatically sorted.</p> <p>- base type: boolean,</p>

	(XPath FASCatalog/FCbody/FCgroup/FCitem/packages/handlingChar/sortableIndicator) 0-1 (N)
specDate	date by which the referenced blanket order must receive full product specific ations (e.g.: colour), according to one of the patterns YYYY-MM-DD, YYYY-MM-DD:HH-MM or YYYY-WW. - base type: string, (XPath FASCatalog/FCbody/FCgroup/FCitem/garComInfo/specDate) 0-1 (p) (XPath FASCatalog/garComInfo/specDate) 0-1 (p) (XPath FASCatalog/FCbody/FCgroup/garComInfo/specDate) 0-1 (p)
stackabilityLevel	This value indicates the level at which the item can be stacked. - base type: integer, (XPath FASCatalog/FCbody/FCgroup/FCitem/packages/handlingChar/stackabilityLevel) 0-1 (N)
street	street and building number identifying a location - base type: string, max length: 80, (XPath FASCatalog/FCheader/supplier/street) 0-1 (XPath FASCatalog/FCheader/buyer/street) 0-1 (XPath FASCatalog/FCheader/thirdParty/street) 0-1
subClass	a code indicating the category (macro-class, class or sub-class) of a commodity classification system the article belongs to. - base type: string, (XPath FASCatalog/FCbody/FCgroup/FCitem/garmentCategory/goodsClassification/subClass) 0-1 (N)
subCountry	short name or code of the sub-country entity - base type: string, max length: 9, (XPath FASCatalog/FCheader/buyer/subCountry) 0-1 (XPath FASCatalog/FCheader/supplier/subCountry) 0-1 (XPath FASCatalog/FCheader/thirdParty/subCountry) 0-1
subDept	name or code of a contact department within a Party - base type: string, max length: 40, (XPath FASCatalog/FCheader/thirdParty/subDept) 0-1 (N) (XPath FASCatalog/FCheader/supplier/subDept) 0-1 (N) (XPath FASCatalog/FCheader/buyer/subDept) 0-1 (N)
taxCategory	duty or tax or fee category - base type: string, cod. table: T62 <a href="http://www.ebiz.enea.it/moda-ml/repository/codelist/v2018-1/gc_T62.xml">http://www.ebiz.enea.it/moda-ml/repository/codelist/v2018-1/gc_T62.xml</a> (XPath FASCatalog/FCbody/FCgroup/FCitem/marketPrice/allowanceCharge/dtScheme/taxCategory) 0-1 (XPath FASCatalog/FCbody/FCgroup/allowanceCharge/dtScheme/taxCategory) 0-1 (XPath FASCatalog/terms/allowanceCharge/dtScheme/taxCategory) 0-1 (XPath FASCatalog/FCbody/FCgroup/FCitem/allowanceCharge/dtScheme/taxCategory) 0-1 (XPath FASCatalog/FCbody/FCgroup/FCitem/dtScheme/taxCategory) 0-1
taxRate	duty or tax or fee percent rate - base type: string, (XPath FASCatalog/FCbody/FCgroup/FCitem/marketPrice/allowanceCharge/dtScheme/taxRate) 0-1 (XPath FASCatalog/FCbody/FCgroup/FCitem/allowanceCharge/dtScheme/taxRate) 0-1 (XPath FASCatalog/terms/allowanceCharge/dtScheme/taxRate) 0-1 (XPath FASCatalog/FCbody/FCgroup/allowanceCharge/dtScheme/taxRate) 0-1 (XPath FASCatalog/FCbody/FCgroup/FCitem/dtScheme/taxRate) 0-1
@taxType	duty or tax or fee type - base type: string, cod. table: T61 <a href="http://www.ebiz.enea.it/moda-ml/repository/codelist/v2018-1/gc_T61.xml">http://www.ebiz.enea.it/moda-ml/repository/codelist/v2018-1/gc_T61.xml</a> (XPath FASCatalog/FCbody/FCgroup/FCitem/dtScheme/@taxType) [Required] (XPath FASCatalog/FCbody/FCgroup/FCitem/allowanceCharge/dtScheme/@taxType) [Required]

	<p>(XPath FASCatalog/FCbody/FCgroup/allowanceCharge/dtScheme/@taxType) [Required]</p> <p>(XPath FASCatalog/FCbody/FCgroup/FCitem/marketPrice/allowanceCharge/dtScheme/@taxType) [Required]</p> <p>(XPath FASCatalog/terms/allowanceCharge/dtScheme/@taxType) [Required]</p>
@TID	<p>serial number wired into the RFID chip</p> <p>- base type: string,</p> <p>(XPath FASCatalog/FCbody/FCgroup/FCitem/packages/EPClist/EPC/@TID) [Optional]</p>
title	<p>document title</p> <p>- base type: string,</p> <p>(XPath FASCatalog/FCbody/FCgroup/picture/title) 0-unbounded (N)</p> <p>- note: Only one instance of this element for each different value of 'ln' attribute (language)</p> <p>(XPath FASCatalog/FCbody/FCgroup/FCitem/picture/title) 0-unbounded (N)</p> <p>- note: Only one instance of this element for each different value of 'ln' attribute (language)</p> <p>(XPath FASCatalog/FCheader/picture/title) 0-unbounded (N)</p> <p>- note: Only one instance of this element for each different value of 'ln' attribute (language)</p>
transCondition	<p>special condition of transport or special service requested to the Forwarder</p> <p>- base type: string, cod. table: T38</p> <p><a href="http://www.ebiz.enea.it/moda-ml/repository/codelist/v2018-1/gc_T38.xml">http://www.ebiz.enea.it/moda-ml/repository/codelist/v2018-1/gc_T38.xml</a></p> <p>(XPath FASCatalog/terms/transInfo/transCondition) 0-3</p>
transConditionText	<p>free text description of the special condition of transport or special service requested to the Forwarder</p> <p>- base type: string, max length: 250,</p> <p>(XPath FASCatalog/terms/transInfo/transConditionText) 0-1 (U)</p>
transMeans	<p>means of transport, in general or referred to a specific leg</p> <p>- base type: string, cod. table: T40</p> <p><a href="http://www.ebiz.enea.it/moda-ml/repository/codelist/v2018-1/gc_T40.xml">http://www.ebiz.enea.it/moda-ml/repository/codelist/v2018-1/gc_T40.xml</a></p> <p>(XPath FASCatalog/terms/transInfo/transMeans) 0-1</p>
transMode	<p>way of transport, in general or referred to the specified leg</p> <p>- base type: string, cod. table: T8</p> <p><a href="http://www.ebiz.enea.it/moda-ml/repository/codelist/v2018-1/gc_T8.xml">http://www.ebiz.enea.it/moda-ml/repository/codelist/v2018-1/gc_T8.xml</a></p> <p>(XPath FASCatalog/terms/transInfo/transMode) 1-1</p>
@transReason	<p>reason for the transport</p> <p>- base type: string, cod. table: NT11</p> <p><a href="http://www.ebiz.enea.it/moda-ml/repository/codelist/v2018-1/gc_NT11.xml">http://www.ebiz.enea.it/moda-ml/repository/codelist/v2018-1/gc_NT11.xml</a></p> <p>(XPath FASCatalog/terms/transInfo/@transReason) [Optional]</p>
@uid	<p>unique element identifier within the xml document</p> <p>- base type: string,</p> <p>(XPath FASCatalog/FCbody/FCgroup/picture/attachment/@uid) [Optional]</p> <p>(XPath FASCatalog/FCbody/FCgroup/FCitem/picture/attachment/@uid) [Optional]</p> <p>(XPath FASCatalog/FCheader/picture/attachment/@uid) [Optional]</p> <p>(XPath FASCatalog/FCheader/refDoc/attachment/@uid) [Optional]</p> <p>(XPath FASCatalog/FCbody/FCgroup/FCitem/refDoc/attachment/@uid) [Optional]</p> <p>(XPath FASCatalog/FCbody/FCgroup/refDoc/attachment/@uid) [Optional]</p>
@um	<p>specification of the unit of measure</p> <p>- base type: string, cod. table: NT7</p> <p><a href="http://www.ebiz.enea.it/moda-ml/repository/codelist/v2018-1/gc_NT7.xml">http://www.ebiz.enea.it/moda-ml/repository/codelist/v2018-1/gc_NT7.xml</a></p> <p>(XPath FASCatalog/garComInfo/yarnPack/yarnReel/yarnReelD/@um) [Required]</p> <p>(XPath FASCatalog/terms/transInfo/grossWeight/@um) [Required]</p> <p>(XPath FASCatalog/garComInfo/yarnPack/yarnReel/yarnReelQty/@um) [Required]</p> <p>(XPath FASCatalog/garComInfo/yarnPack/yarnReel/yarnReelH/@um) [Required]</p> <p>(XPath FASCatalog/terms/transInfo/netWeight/@um) [Required]</p>

	<p>(XPath FASCatalog/FCbody/FCgroup/FCitem/garComInfo/yarnPack/yarnReel/yarnReelQty/@um) [Required]</p> <p>(XPath FASCatalog/terms/allowanceCharge/@um) [Optional] (a)</p> <p>(XPath FASCatalog/FCbody/FCgroup/FCitem/garComInfo/yarnPack/yarnReel/yarnReelD/@um) [Required]</p> <p>(XPath FASCatalog/FCbody/FCgroup/FCitem/garComInfo/yarnPack/yarnReel/yarnReelH/@um) [Required]</p> <p>(XPath FASCatalog/FCheader/picture/width/@um) [Required]</p> <p>(XPath FASCatalog/FCbody/FCgroup/FCitem/picture/nominalHeigth/@um) [Optional]</p> <p>(XPath FASCatalog/FCbody/FCgroup/garComInfo/yarnPack/yarnReel/yarnReelQty/@um) [Required]</p> <p>(XPath FASCatalog/FCheader/picture/nominalWidth/@um) [Optional] (a)</p> <p>(XPath FASCatalog/FCbody/FCgroup/FCitem/packages/packageDim/height/@um) [Required]</p> <p>(XPath FASCatalog/FCbody/FCgroup/FCitem/packages/minItemsPerPackage/@um) [Required]</p> <p>(XPath FASCatalog/FCbody/FCgroup/FCitem/packages/packageDim/width/@um) [Required]</p> <p>(XPath FASCatalog/FCbody/FCgroup/FCitem/packages/itemsPerPackage/@um) [Required]</p> <p>(XPath FASCatalog/FCbody/FCgroup/garComInfo/yarnPack/yarnReel/yarnReelH/@um) [Required]</p> <p>(XPath FASCatalog/FCbody/FCgroup/FCitem/productDim/width/@um) [Required]</p> <p>(XPath FASCatalog/FCbody/FCgroup/FCitem/packages/handlingChar/yarnPack/yarnReel/yarnReelH/@um) [Required]</p> <p>(XPath FASCatalog/FCbody/FCgroup/FCitem/packages/handlingChar/volume/@um) [Required]</p> <p>(XPath FASCatalog/FCbody/FCgroup/FCitem/productDim/length/@um) [Required]</p> <p>(XPath FASCatalog/FCbody/FCgroup/FCitem/packages/handlingChar/yarnPack/yarnReel/yarnReelQty/@um) [Required]</p> <p>(XPath FASCatalog/FCbody/FCgroup/FCitem/packages/handlingChar/netWeight/@um) [Required]</p> <p>(XPath FASCatalog/FCbody/FCgroup/FCitem/fashionProd/csRange/sizeMatrix/sizeRow/qty/@um) [Required]</p> <p>(XPath FASCatalog/FCheader/picture/nominalHeigth/@um) [Optional] (a)</p> <p>(XPath FASCatalog/FCbody/FCgroup/FCitem/packages/handlingChar/yarnPack/yarnReel/yarnReelD/@um) [Required]</p> <p>(XPath FASCatalog/FCbody/FCgroup/FCitem/packages/handlingChar/grossWeight/@um) [Required]</p> <p>(XPath FASCatalog/FCbody/FCgroup/garComInfo/yarnPack/yarnReel/yarnReelD/@um) [Required]</p> <p>(XPath FASCatalog/FCheader/picture/height/@um) [Required]</p> <p>(XPath FASCatalog/FCbody/FCgroup/picture/nominalWidth/@um) [Optional] (a)</p> <p>(XPath FASCatalog/FCbody/FCgroup/picture/nominalHeigth/@um) [Optional] (a)</p> <p>(XPath FASCatalog/FCbody/FCgroup/FCitem/allowanceCharge/@um) [Optional] (a)</p> <p>(XPath FASCatalog/FCbody/FCgroup/FCitem/productDim/height/@um) [Required]</p> <p>(XPath FASCatalog/FCbody/FCgroup/FCitem/picture/nominalWidth/@um) [Optional]</p> <p>(XPath FASCatalog/FCbody/FCgroup/picture/height/@um) [Required]</p> <p>(XPath FASCatalog/FCbody/FCgroup/picture/width/@um) [Required]</p> <p>(XPath FASCatalog/FCbody/FCgroup/FCitem/packages/packageDim/length/@um) [Required]</p> <p>(XPath FASCatalog/FCbody/FCgroup/FCitem/picture/width/@um) [Required]</p> <p>(XPath FASCatalog/FCbody/FCgroup/FCitem/marketPrice/catalogPrice/@um) [Required]</p> <p>(XPath FASCatalog/FCbody/FCgroup/FCitem/marketPrice/allowanceCharge/@um) [Optional]</p> <p>(XPath FASCatalog/FCbody/FCgroup/allowanceCharge/@um) [Optional] (a)</p> <p>(XPath FASCatalog/FCbody/FCgroup/FCitem/picture/height/@um) [Required]</p>
unitOfMeasure	<p>unit of measure.</p> <p>- base type: string,</p> <p>(XPath FASCatalog/FCbody/FCgroup/FCitem/unitOfMeasure) 0-99 (N)</p> <p>- note: <i>Unit of measurement in which the article is expressed. It is possible to indicate more than one distinguishing them with the measureQualifier attribute</i></p>

unitOfSourceMeasure	<p>unit of measure.</p> <p>- base type: string, (XPath FASCatalog/FCbody/FCgroup/FCitem/measureConversion/unitOfSourceMeasure) 1-1 (N)</p> <p>- note: <i>Initial unit of measure (source) in which the article is expressed</i></p>
unitOfTargetMeasure	<p>unit of measure.</p> <p>- base type: string, (XPath FASCatalog/FCbody/FCgroup/FCitem/measureConversion/unitOfTargetMeasure) 1-1 (N)</p> <p>- note: <i>Unit of measure (target) obtained by applying the conversion parameter (conversionRate). It is a further unit of measurement in which the article can be expressed.</i></p>
uri	<p>Uniform Resource Identifier (URI) that identifies the external object as an Internet resource</p> <p>- base type: normalizedString, (XPath FASCatalog/FCbody/FCgroup/FCitem/refDoc/attachment/externalReference/uri) 1-1 (N)</p> <p>(XPath FASCatalog/FCheader/refDoc/attachment/externalReference/uri) 1-1 (N)</p> <p>(XPath FASCatalog/FCbody/FCgroup/refDoc/attachment/externalReference/uri) 1-1 (N)</p> <p>(XPath FASCatalog/FCheader/picture/attachment/externalReference/uri) 1-1 (N)</p> <p>(XPath FASCatalog/FCbody/FCgroup/FCitem/picture/attachment/externalReference/uri) 1-1 (N)</p> <p>(XPath FASCatalog/FCbody/FCgroup/picture/attachment/externalReference/uri) 1-1 (N)</p>
@useProfile	<p>use profile to which the present document is compliant if it was agreed by the parties. It is suggested a URI with reference to the firms or the URL of the profile.</p> <p>- base type: string, (XPath FASCatalog/@useProfile) [Optional]</p>
validityEnd	<p>date by which the validity ends, according to one of the patterns YYYY-MM-DD, YYYY-MM-DD:HH-MM or YYYY-WW.</p> <p>- base type: string, (XPath FASCatalog/FCbody/FCgroup/FCitem/picture/validityEnd) 0-1 (XPath FASCatalog/FCbody/FCgroup/picture/validityEnd) 0-1 (XPath FASCatalog/FCheader/validityEnd) 0-1 (XPath FASCatalog/FCheader/picture/validityEnd) 0-1</p>
validityStart	<p>date by which the validity starts, according to one of the patterns YYYY-MM-DD, YYYY-MM-DD:HH-MM or YYYY-WW.</p> <p>- base type: string, (XPath FASCatalog/FCbody/FCgroup/FCitem/picture/validityStart) 0-1 (XPath FASCatalog/FCheader/picture/validityStart) 0-1 (XPath FASCatalog/FCheader/validityStart) 0-1 (XPath FASCatalog/FCbody/FCgroup/picture/validityStart) 0-1</p>
variantCode	<p>Code of variant used for fashion product.</p> <p>- base type: string, (XPath FASCatalog/FCbody/FCgroup/FCitem/fashionProd/csRange/garmentVariant/variantCode) 1-1 (N)</p> <p>(XPath FASCatalog/FCbody/FCgroup/FCitem/fashionProd/garmentCode/garmentCodeB/garmentVariant/variantCode) 1-1 (N)</p>
variantType	<p>Type of variant used for fashion product (examples: 'treatment', 'washing type', 'size class',...)</p> <p>- base type: string, (XPath FASCatalog/FCbody/FCgroup/FCitem/fashionProd/csRange/garmentVariant/variantType) 1-1 (N)</p> <p>(XPath FASCatalog/FCbody/FCgroup/FCitem/fashionProd/garmentCode/garmentCodeB/garmentVariant/variantType) 1-1 (N)</p>

@VAT	VAT rate or code (DEPRECATED, use dtScheme element) - base type: string, cod. table: NT16 <a href="http://www.ebiz.enea.it/moda-ml/repository/codelist/v2018-1/gc_NT16.xml">http://www.ebiz.enea.it/moda-ml/repository/codelist/v2018-1/gc_NT16.xml</a> (XPath FASCatalog/FCbody/FCgroup/allowanceCharge/@VAT) [Optional] (XPath FASCatalog/FCbody/FCgroup/FCitem/lineN/@VAT) [Optional] - nota: <i>Deprecated, prefer dtScheme when available.</i> (XPath FASCatalog/terms/allowanceCharge/@VAT) [Optional] (XPath FASCatalog/FCbody/FCgroup/FCitem/marketPrice/allowanceCharge/@VAT) [Optional] (XPath FASCatalog/FCheader/thirdParty/@VAT) [Optional] (XPath FASCatalog/FCbody/FCgroup/FCitem/allowanceCharge/@VAT) [Optional]
@version	Dictionary version from which the instance has been created - base type: string, cod. table: NT100 <a href="http://www.ebiz.enea.it/moda-ml/repository/codelist/v2018-1/gc_NT100.xml">http://www.ebiz.enea.it/moda-ml/repository/codelist/v2018-1/gc_NT100.xml</a> (XPath FASCatalog/@version) [Optional] [Default= 2018-1]
volume	effective volume of a specified object - base type: decimal, min inclusive: 0, fraction digits: 2, (XPath FASCatalog/FCbody/FCgroup/FCitem/packages/handlingChar/volume) 0-1
width	effective width of a specified object - base type: decimal, min inclusive: 0, fraction digits: 2, (XPath FASCatalog/FCbody/FCgroup/picture/width) 0-1 - note: the 'um' attribute of this element must be 'E37' (pixel) (XPath FASCatalog/FCbody/FCgroup/FCitem/picture/width) 0-1 - note: the 'um' attribute of this element must be 'E37' (pixel) (XPath FASCatalog/FCheader/picture/width) 0-1 - note: the 'um' attribute of this element must be 'E37' (pixel) (XPath FASCatalog/FCbody/FCgroup/FCitem/productDim/width) 0-1 (p) (XPath FASCatalog/FCbody/FCgroup/FCitem/packages/packageDim/width) 0-1
yarnConeAngle	tapering angle of the cone on which a yarn is reeled - base type: positiveInteger, (XPath FASCatalog/FCbody/FCgroup/FCitem/garComInfo/yarnPack/yarnReel/yarnConeAngle) 0-1 (XPath FASCatalog/garComInfo/yarnPack/yarnReel/yarnConeAngle) 0-1 (XPath FASCatalog/FCbody/FCgroup/garComInfo/yarnPack/yarnReel/yarnConeAngle) 0-1 (XPath FASCatalog/FCbody/FCgroup/FCitem/packages/handlingChar/yarnPack/yarnReel/yarnConeAngle) 0-1
yarnOutWrap	code specifying the type of outer wrapping or packing of a yarn - base type: string, cod. table: T33 <a href="http://www.ebiz.enea.it/moda-ml/repository/codelist/v2018-1/gc_T33.xml">http://www.ebiz.enea.it/moda-ml/repository/codelist/v2018-1/gc_T33.xml</a> (XPath FASCatalog/FCbody/FCgroup/FCitem/packages/handlingChar/yarnPack/yarnOutWrap) 0-1 (XPath FASCatalog/FCbody/FCgroup/FCitem/garComInfo/yarnPack/yarnOutWrap) 0-1 (XPath FASCatalog/FCbody/FCgroup/garComInfo/yarnPack/yarnOutWrap) 0-1 (XPath FASCatalog/garComInfo/yarnPack/yarnOutWrap) 0-1
yarnOutWrapText	free text specifying the type of outer wrapping or packing of a yarn - base type: string, max length: 250, (XPath FASCatalog/FCbody/FCgroup/garComInfo/yarnPack/yarnOutWrapText) 0-1 (U) (XPath FASCatalog/FCbody/FCgroup/FCitem/packages/handlingChar/yarnPack/yarnOutWrapText) 0-1 (U) (XPath FASCatalog/garComInfo/yarnPack/yarnOutWrapText) 0-1 (U) (XPath FASCatalog/FCbody/FCgroup/FCitem/garComInfo/yarnPack/yarnOutWrapText) 0-1 (U)
yarnReelD	diameter of the bobbin used for a yarn product - base type: decimal, min inclusive: 0, fraction digits: 2, (XPath FASCatalog/FCbody/FCgroup/FCitem/garComInfo/yarnPack/yarnReel/yarnReelD) 0-1



	<p>(XPath FASCatalog/FCbody/FCgroup/garComInfo/yarnPack/yarnReel/yarnReelID) 0-1</p> <p>(XPath FASCatalog/FCbody/FCgroup/FCitem/packages/handlingChar/yarnPack/yarnReel/yarnReelID) 0-1</p> <p>(XPath FASCatalog/garComInfo/yarnPack/yarnReel/yarnReelID) 0-1</p>
yarnReelH	<p>height of the bobbin used a yarn product</p> <p>- base type: decimal, min inclusive: 0, fraction digits: 2,</p> <p>(XPath FASCatalog/FCbody/FCgroup/garComInfo/yarnPack/yarnReel/yarnReelH) 0-1</p> <p>(XPath FASCatalog/FCbody/FCgroup/FCitem/packages/handlingChar/yarnPack/yarnReel/yarnReelH) 0-1</p> <p>(XPath FASCatalog/FCbody/FCgroup/FCitem/garComInfo/yarnPack/yarnReel/yarnReelH) 0-1</p> <p>(XPath FASCatalog/garComInfo/yarnPack/yarnReel/yarnReelH) 0-1</p>
yarnReelQty	<p>quantity of yarn (by weight or length) wound upon a bobbin</p> <p>- base type: decimal, min inclusive: 0, fraction digits: 2,</p> <p>(XPath FASCatalog/FCbody/FCgroup/FCitem/packages/handlingChar/yarnPack/yarnReel/yarnReelQty) 0-2</p> <p>(XPath FASCatalog/FCbody/FCgroup/FCitem/garComInfo/yarnPack/yarnReel/yarnReelQty) 0-2</p> <p>(XPath FASCatalog/garComInfo/yarnPack/yarnReel/yarnReelQty) 0-2</p> <p>(XPath FASCatalog/FCbody/FCgroup/garComInfo/yarnPack/yarnReel/yarnReelQty) 0-2</p>
yarnReelWrap	<p>type of wrapping in which a package of yarn is wrapped</p> <p>- base type: string, cod. table: T32</p> <p><a href="http://www.ebiz.enea.it/moda-ml/repository/codelist/v2018-1/gc_T32.xml">http://www.ebiz.enea.it/moda-ml/repository/codelist/v2018-1/gc_T32.xml</a></p> <p>(XPath FASCatalog/FCbody/FCgroup/garComInfo/yarnPack/yarnInWrap/yarnReelWrap) 1-1</p> <p>(XPath FASCatalog/garComInfo/yarnPack/yarnInWrap/yarnReelWrap) 1-1</p> <p>(XPath FASCatalog/FCbody/FCgroup/FCitem/packages/handlingChar/yarnPack/yarnInWrap/yarnReelWrap) 1-1</p> <p>(XPath FASCatalog/FCbody/FCgroup/FCitem/garComInfo/yarnPack/yarnInWrap/yarnReelWrap) 1-1</p>

## 2.3 Suggested best practices

**FASCatalog/FCheader/refDoc/docID (identification number of the referenced document SINCE 2008-1 ITS USE IN THE HEADER IS DISCOURAGED (REPLACED BY msgID))**

numberingOrg indicates the role that produced the document identifier (it is allowed to declare two different ones -e.g. customer and supplier - with two docID with different numberingOrg

**FASCatalog/FCbody/FCgroup/FCitem/refDoc/docID (identification number of the referenced document SINCE 2008-1 ITS USE IN THE HEADER IS DISCOURAGED (REPLACED BY msgID))**

numberingOrg indicates the role that produced the document identifier (it is allowed to declare two different ones -e.g. customer and supplier - with two docID with different numberingOrg

**FASCatalog/FCbody/FCgroup/refDoc/docID (identification number of the referenced document SINCE 2008-1 ITS USE IN THE HEADER IS DISCOURAGED (REPLACED BY msgID))**

numberingOrg indicates the role that produced the document identifier (it is allowed to declare two different ones -e.g. customer and supplier - with two docID with different numberingOrg

**FASCatalog/FCbody/FCgroup/FCitem/marketPrice/  
geographicArea/geographicAreaText (text identifying a geographic area)**

using a code (geographicAreaCode) is preferable when the area coincides with a state

**FASCatalog/FCbody/FCgroup/FCitem/picture/  
attachment/externalReference/mimeType (mime type of the external object)**

Use coding from IANA <http://www.iana.org/assignments/media-types/media-types.xml>

**FASCatalog/FCheader/refDoc/attachment/externalReference/mimeType (mime type of the external object)**

Use coding from IANA <http://www.iana.org/assignments/media-types/media-types.xml>

**FASCatalog/FCbody/FCgroup/refDoc/attachment/  
externalReference/mimeType (mime type of the external object)**

Use coding from IANA <http://www.iana.org/assignments/media-types/media-types.xml>

**FASCatalog/FCbody/FCgroup/FCitem/refDoc/  
attachment/externalReference/mimeType (mime type of the external object)**

Use coding from IANA <http://www.iana.org/assignments/media-types/media-types.xml>

**FASCatalog/FCbody/FCgroup/picture/attachment/  
externalReference/mimeType (mime type of the external object)**

Use coding from IANA <http://www.iana.org/assignments/media-types/media-types.xml>

**FASCatalog/FCheader/picture/attachment/externalReference/mimeType (mime type of the external object)**

Use coding from IANA <http://www.iana.org/assignments/media-types/media-types.xml>

**FASCatalog/FCbody/FCgroup/FCitem/fashionProd/  
csRange/sizeMatrix/sizeRow/itemsList/itemIdentification/serialN (serial number used for the identification of a physical unit)**

in the case of garment with RFID for anti-counterfeiting, RFID EPCGlobal for logistics and NFC for the customer experience there should be three serial elements with pairs of attributes numberingOrg/idQualifier: "CL"/"RFID", "GS1"/"RFID", "CL"/"NFC".

## 2.4 Enumeration tables

List of enumeration tables used in the XML document. You can find the corresponding codes at:  
<http://www.ebiz-tcf.eu/moda-ml/imple/moda-ml-2018-1.asp?lingua=en&pag=6>

### Legenda

- N: new table
- U: updated properties

NT100 - eBIZ TCFUpstream version  
NT11 - transport causal  
NT16 - VAT rate or code  
NT2 - third party qualifier  
NT29 - format of a date  
NT3 - data format  
NT4 - end use  
NT43 - operational code qualifier (N)  
NT51 - Filling Criterion for Package homogeneity (N)  
NT6 - coding system owner/issuer  
NT60 - language, codes from ISO 639-1 (subset) (N)  
NT7 - unit of measure (U)  
NT71 - picture resolution type (N)  
NT72 - picture final use type (N)  
T1 - terms of payment  
T10 - ISO3166 - Country  
T11 - transport package type (U)  
T19 - fibre type  
T2 - Modes of payment  
T21 - type of document  
T29 - type of yarn package  
T3 - terms of delivery  
T30 - support of yarn package - material  
T32 - yarn reel wrapping type  
T33 - yarn outer packing  
T38 - transport conditions  
T4 - fabric piece inner packing (wrapping) 1  
T40 - type of transport means  
T41 - type of Allowance or Charge  
T421 - size system: nationality  
T422 - size system: market segment  
T423 - size system: base  
T44 - additional code type  
T48 - garment part type  
T5 - fabric piece inner packing (wrapping) 2  
T6 - fabric piece outer packing  
T61 - duty or tax or fee type  
T62 - duty or tax or fee category  
T8 - Modes of Transport  
T9 - ISO4217 - Currency



# Annex A

Representative images of the principal complex elements' structure.

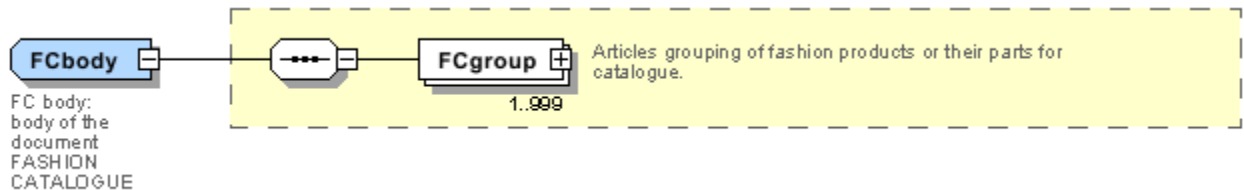
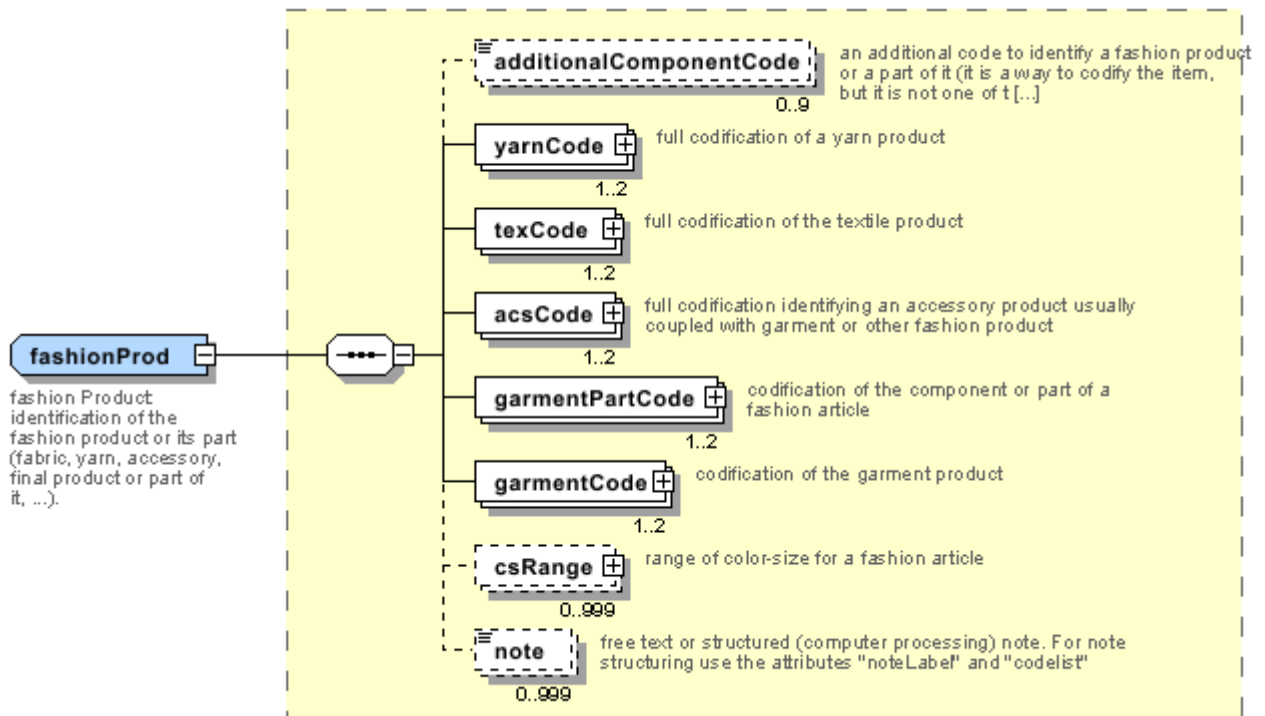
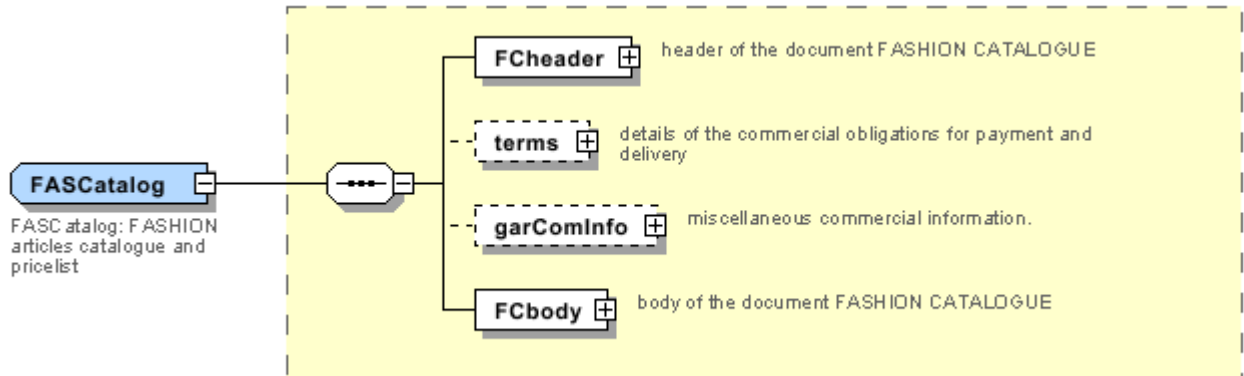

**FCgroup**  
 FC Group: Articles grouping of fashion products or their parts for catalogue.

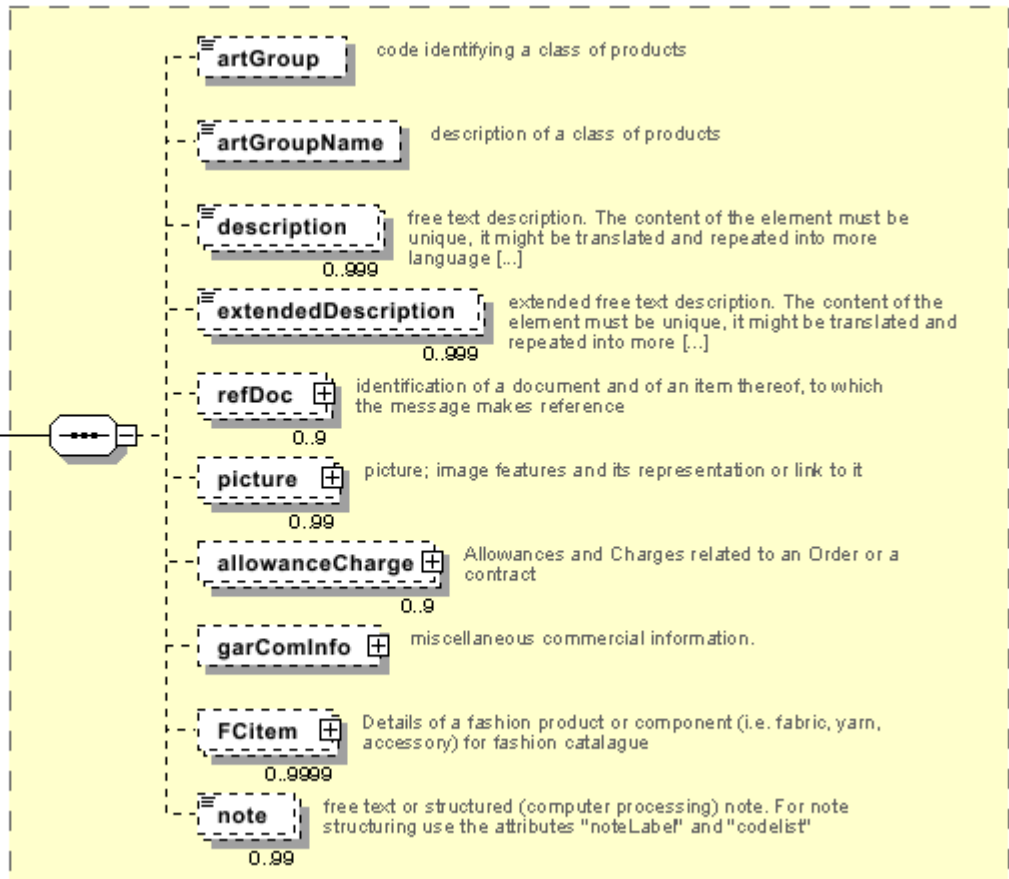

**FCheader**  
 FC header:  
 header of the  
 document  
 FASHION  
 CATALOGUE

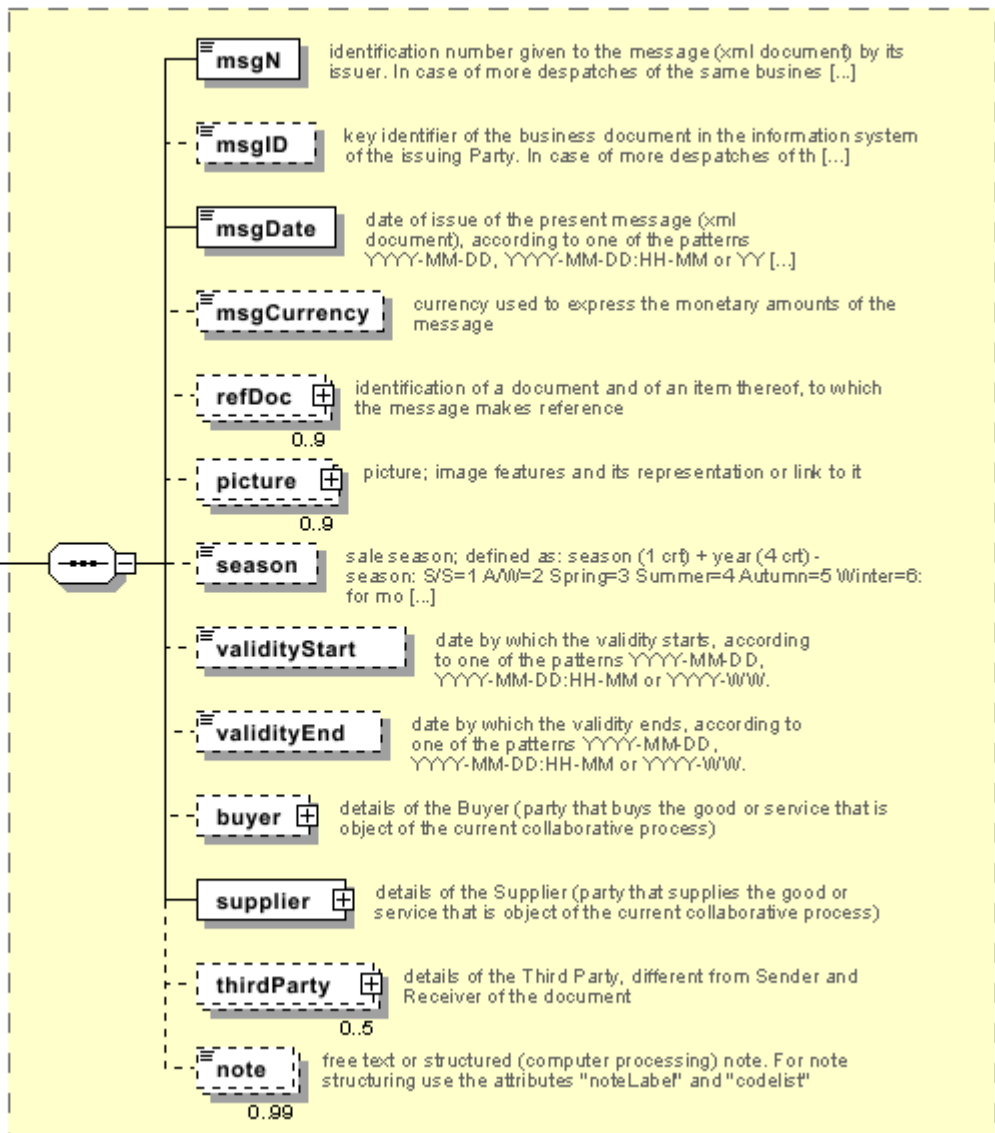



**FCItem**  
 FC Item: Details of a fashion product or component (i.e. fabric, yarn, accessory) for fashion catalogue

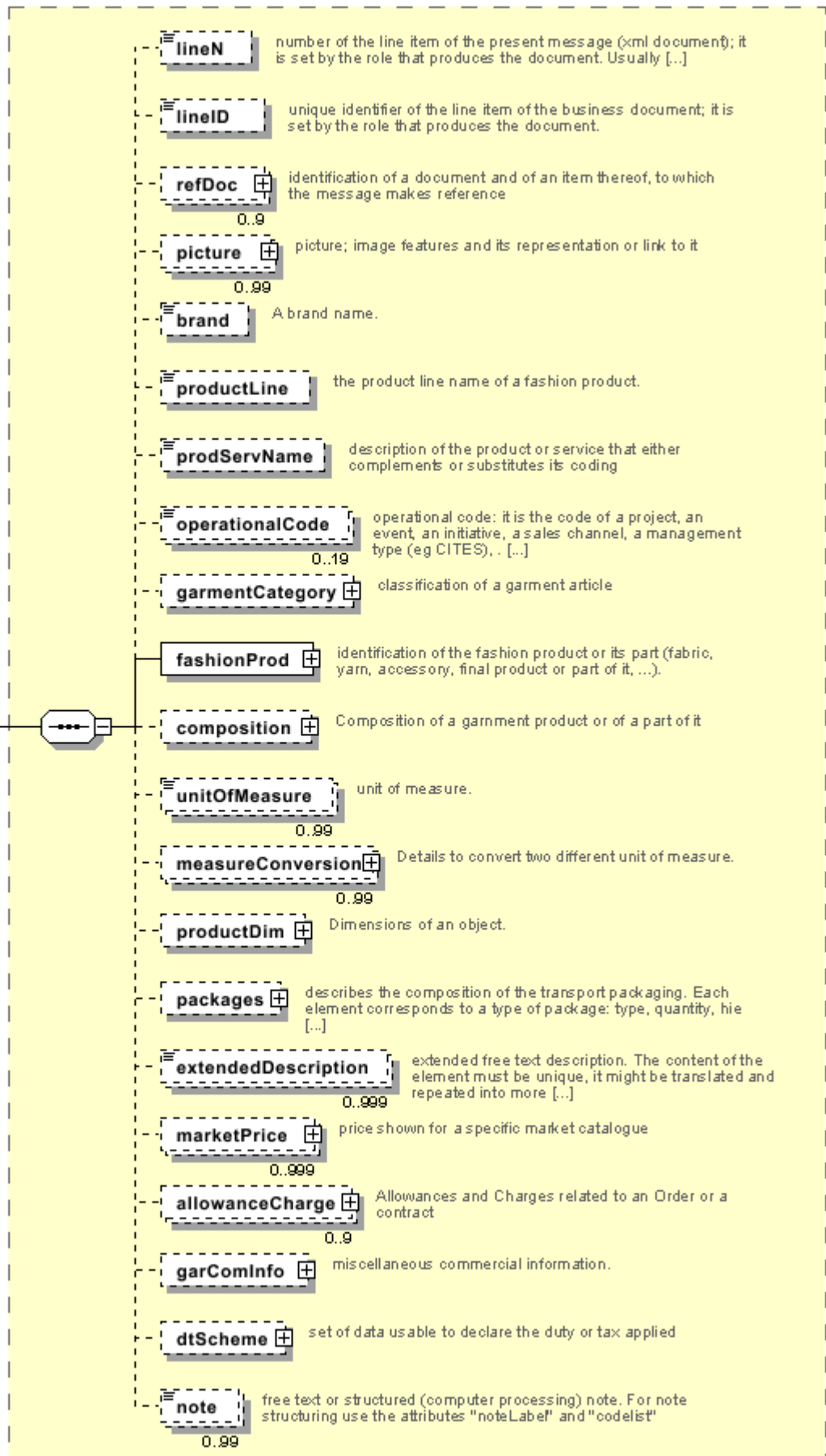

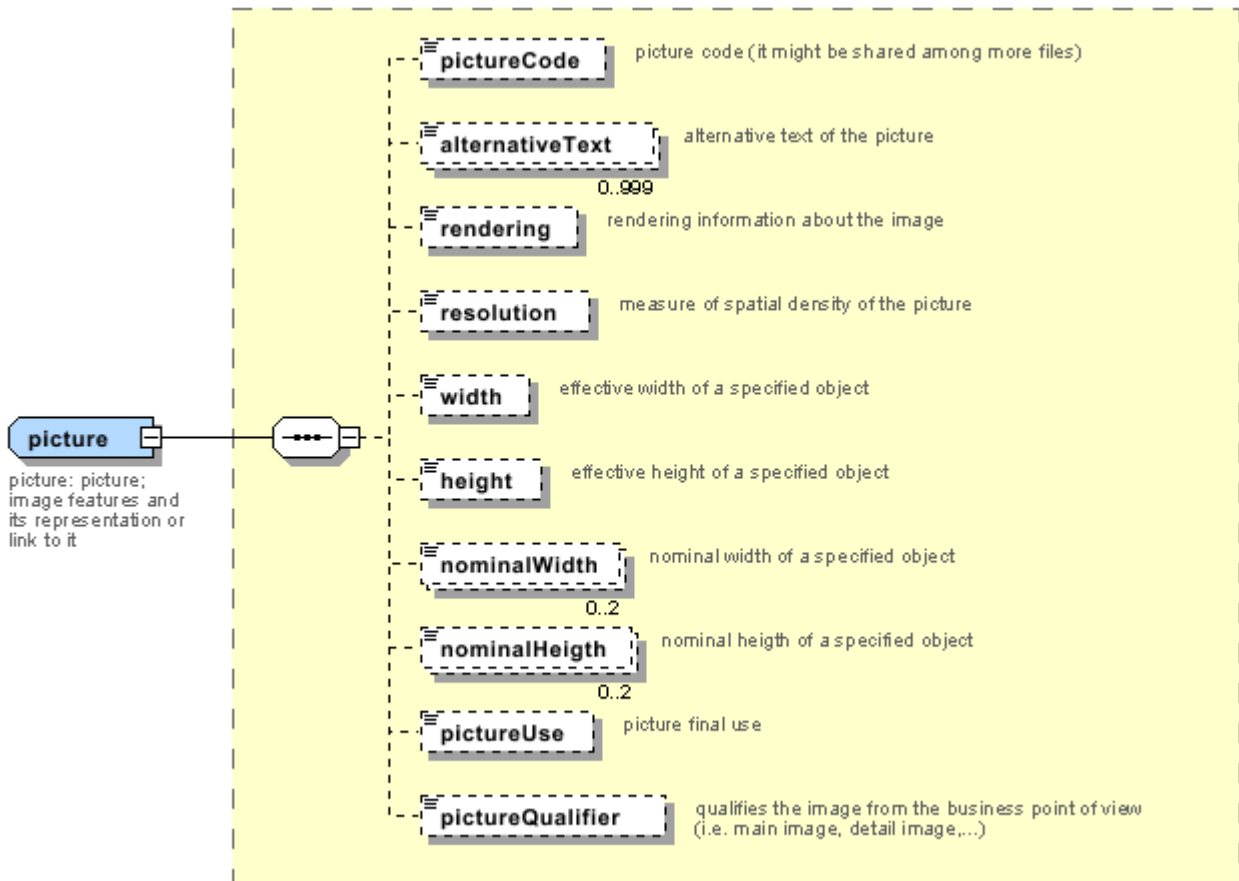
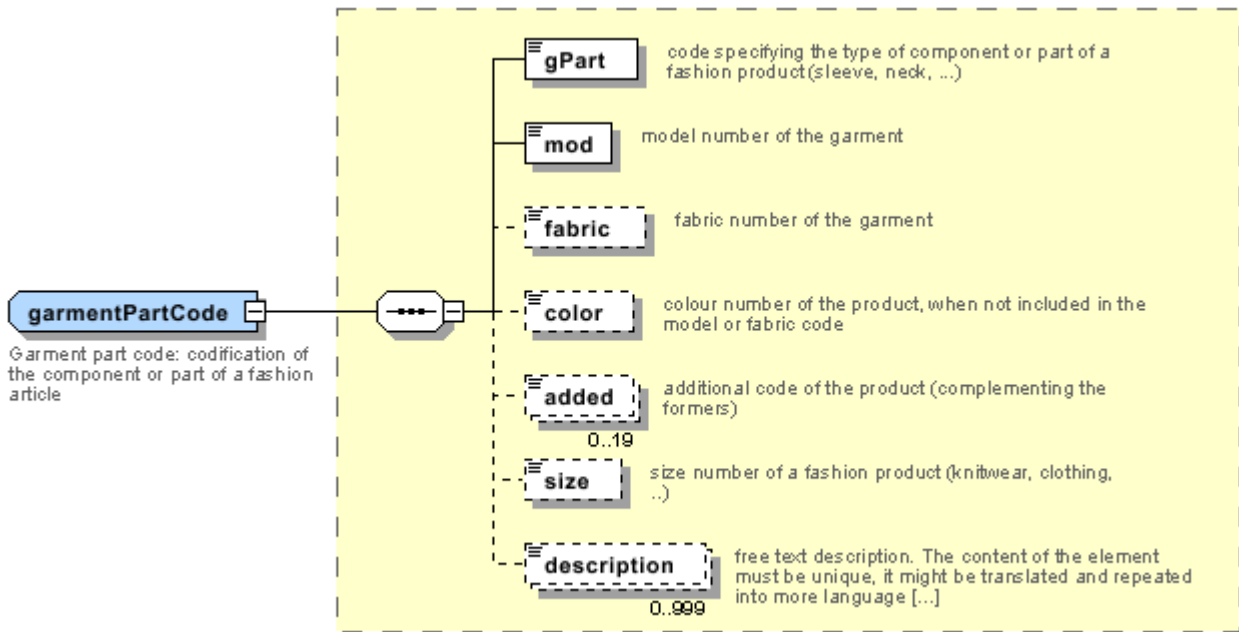

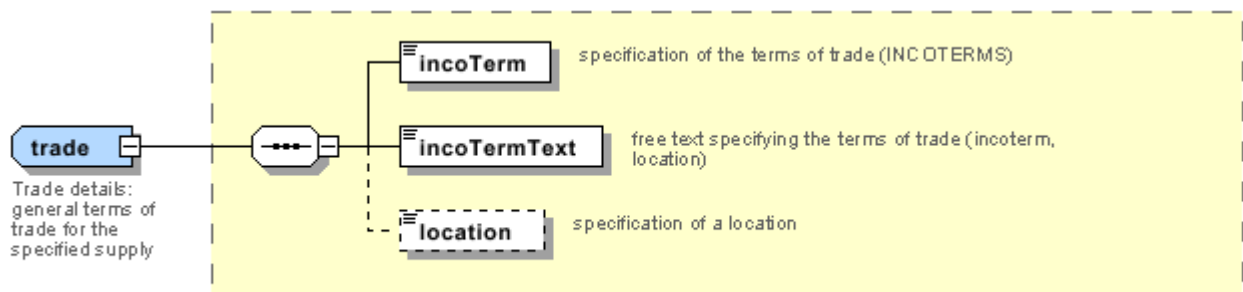
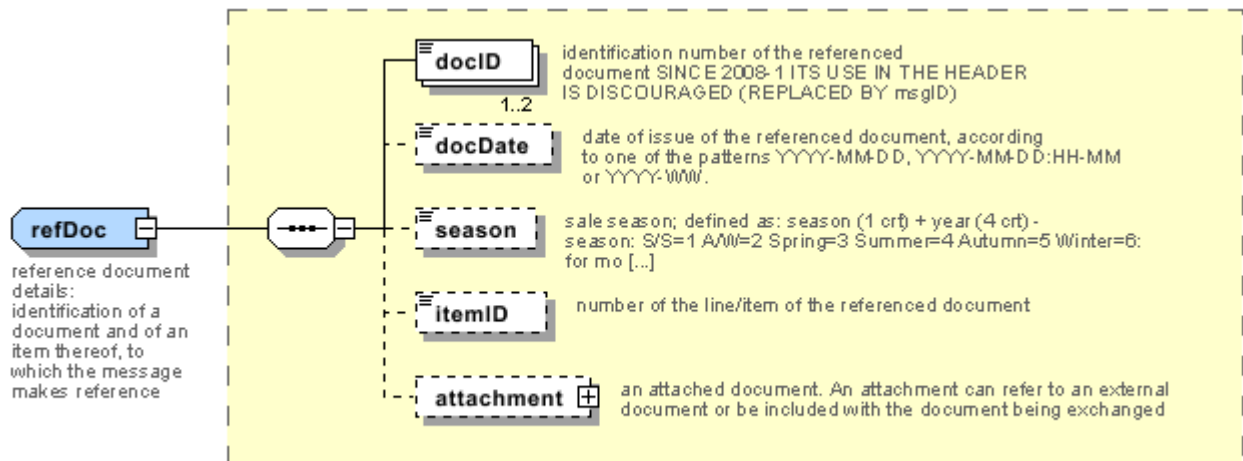
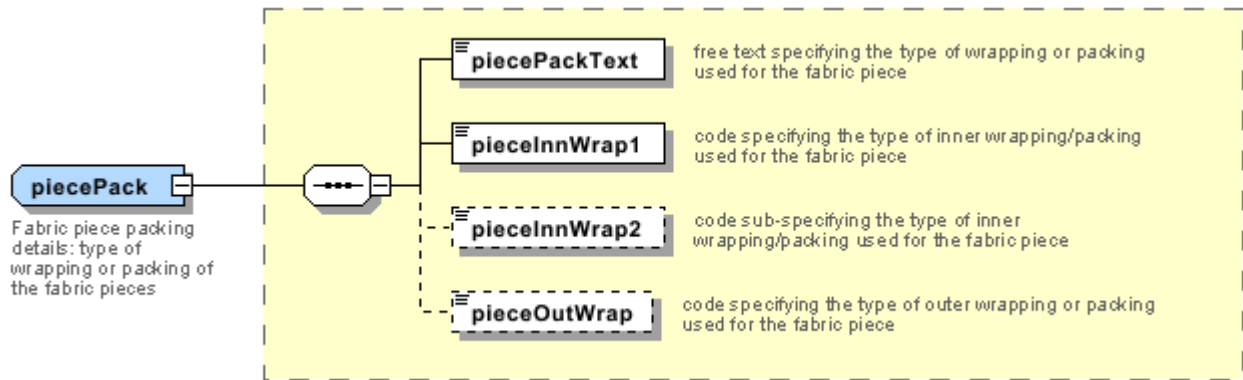



## Annex B

### NT100 - eBIZ TCFUpstream version

dictionary version

Agency name: eBIZ

tabella cod.: NT100

File codes list (Generic code): [http://www.ebiz.enea.it/moda-ml/repository/codelist/v2018-1/gc\\_NT100.xml](http://www.ebiz.enea.it/moda-ml/repository/codelist/v2018-1/gc_NT100.xml)

Code	Description	Adoption note	Version status	Date of insertion
2013-1	v2013-1			01/07/2013
2018-1	v2018-1		(N)	04/11/2018
draft	draft		(N)	08/09/2017

### NT11 - transport causal

reason for the transport

Agency name: eBIZ

tabella cod.: NT11

File codes list (Generic code): [http://www.ebiz.enea.it/moda-ml/repository/codelist/v2018-1/gc\\_NT11.xml](http://www.ebiz.enea.it/moda-ml/repository/codelist/v2018-1/gc_NT11.xml)

Code	Description	Adoption note	Version status	Date of insertion
FOC	free of charge			
FRW	return from re-works			
FST	return from storage			
FWW	return from view			
FWK	return from works			
IST	in storage			
NWK	return non-worked			
RJC	return from rejection			
SEL	to sell			
STO	to storage			
VEW	to view			
WRK	to works			

### NT16 - VAT rate or code

VAT rate or code ( DEPRECATED, use dtScheme element )

tabella cod.: NT16

File codes list (Generic code): [http://www.ebiz.enea.it/moda-ml/repository/codelist/v2018-1/gc\\_NT16.xml](http://www.ebiz.enea.it/moda-ml/repository/codelist/v2018-1/gc_NT16.xml)

## NT2 - third party qualifier

Third Party role qualifier

Agency name: eBIZ

tabella cod.: NT2

File codes list (Generic code): [http://www.ebiz.enea.it/moda-ml/repository/codelist/v2018-1/gc\\_NT2.xml](http://www.ebiz.enea.it/moda-ml/repository/codelist/v2018-1/gc_NT2.xml)

Code	Description	Adoption note	Version status	Date of insertion
AG	Sales Agent			
AU	Auditor		(N)	08/04/2019
CE	Certification authority		(N)	08/04/2019
CO	Quality Controller			
DC	Response to			
DF	Invoicee			
DI	Copy to (CC)			28/10/2014
DM	Consignee			
DP	Consignment address (Delivery Party)			
IM	Importer			
OR	Originator			10/09/2014
SC	Sub contractor		(N)	10/04/2019
SM	Service/ePlatform manager		(N)	08/04/2019
SP	Forwarder			
TX	Tax Representative			

## NT29 - format of a date

format used for the date

Agency name: eBIZ

tabella cod.: NT29

File codes list (Generic code): [http://www.ebiz.enea.it/moda-ml/repository/codelist/v2018-1/gc\\_NT29.xml](http://www.ebiz.enea.it/moda-ml/repository/codelist/v2018-1/gc_NT29.xml)

Code	Description	Adoption note	Version status	Date of insertion
------	-------------	---------------	----------------	-------------------

D	YYYY-MM-DD			
M	YYYY-MM-DD:HH-MM			
W	YYYY-WW			

### NT3 - data format

format of a string according to a customized User rule (local rule)

Agency name: eBIZ

tabella cod.: NT3

File codes list (Generic code): [http://www.ebiz.enea.it/moda-ml/repository/codelist/v2018-1/gc\\_NT3.xml](http://www.ebiz.enea.it/moda-ml/repository/codelist/v2018-1/gc_NT3.xml)

Code	Description	Adoption note	Version status	Date of insertion
EN4	GS1-GLN			01/07/2013
MD	mutually agreed			

### NT4 - end use

specifies the final use of the product

Agency name: eBIZ

tabella cod.: NT4

File codes list (Generic code): [http://www.ebiz.enea.it/moda-ml/repository/codelist/v2018-1/gc\\_NT4.xml](http://www.ebiz.enea.it/moda-ml/repository/codelist/v2018-1/gc_NT4.xml)

Code	Description	Adoption note	Version status	Date of insertion
PC	test piece			
PR	production			
SA	Sample		(N)	10/09/2014
SC	samples card			
TI	patch			
TP	(test cut)			

### NT43 - operational code qualifier (N)

Agency name: eBIZ

tabella cod.: NT43

File codes list (Generic code): [http://www.ebiz.enea.it/moda-ml/repository/codelist/v2018-1/gc\\_NT43.xml](http://www.ebiz.enea.it/moda-ml/repository/codelist/v2018-1/gc_NT43.xml)

Code	Description	Adoption note	Version status	Date of insertion
1	event		(N)	08/09/2017
2	sales channel		(N)	08/09/2017
3	goods management type		(N)	08/09/2017
4	special initiative		(N)	08/09/2017

#### NT51 - Filling Criterion for Package homogeneity (N)

Filling Criterion for Package homogeneity

Agency name: eBIZ

tabella cod.: NT51

File codes list (Generic code): [http://www.ebiz.enea.it/moda-ml/repository/codelist/v2018-1/gc\\_NT51.xml](http://www.ebiz.enea.it/moda-ml/repository/codelist/v2018-1/gc_NT51.xml)

Code	Description	Adoption note	Version status	Date of insertion
COL	Colour		(N)	08/09/2017
MOD	Model		(N)	08/09/2017
SIZ	Size		(N)	08/09/2017

#### NT6 - coding system owner/issuer

code specifying the organisation who has created or owns the coding or numbering system

Agency name: eBIZ

tabella cod.: NT6

File codes list (Generic code): [http://www.ebiz.enea.it/moda-ml/repository/codelist/v2018-1/gc\\_NT6.xml](http://www.ebiz.enea.it/moda-ml/repository/codelist/v2018-1/gc_NT6.xml)

Code	Description	Adoption note	Version status	Date of insertion
CL	Customer/buyer			
CO	Quality Controller			
EB	eBIZ	replaces 'ML'	(N)	18/03/2019
EN	GS1 ( ex-EAN International )			
ES	e-Stockflow			
FO	Supplier			
GS	GS1			01/07/2013
MF	VAT identifier		(U)	
ML	Moda-ML	DEPRECATED	(U)	



SP	Service Provider			
----	------------------	--	--	--

**NT60 - language, codes from ISO 639-1 (subset) (N)**

Agency name: eBIZ / ISO

tabella cod.: NT60

File codes list (Generic code): [http://www.ebiz.enea.it/moda-ml/repository/codelist/v2018-1/gc\\_NT60.xml](http://www.ebiz.enea.it/moda-ml/repository/codelist/v2018-1/gc_NT60.xml)

Code	Description	Adoption note	Version status	Date of insertion
af	Afrikaans		(N)	31/01/2019
ar	Arabic		(N)	31/01/2019
be	Belarusian		(N)	31/01/2019
bg	Bulgarian		(N)	31/01/2019
bn	Bengali		(N)	31/01/2019
bo	Tibetan		(N)	31/01/2019
bs	Bosnian		(N)	31/01/2019
ca	Catalan, Valencian		(N)	31/01/2019
cs	Czech		(N)	31/01/2019
da	Danish		(N)	31/01/2019
de	German		(N)	31/01/2019
el	Greek, Modern (1453-)		(N)	31/01/2019
en	English		(N)	31/01/2019
eo	Esperanto		(N)	31/01/2019
es	Spanish, Castilian		(N)	31/01/2019
et	Estonian		(N)	31/01/2019
eu	Basque		(N)	31/01/2019
F	Female		(N)	15/04/2019
fa	Persian		(N)	31/01/2019
fi	Finnish		(N)	31/01/2019
fr	French		(N)	31/01/2019
ga	Irish		(N)	31/01/2019
gd	Gaelic, Scottish Gaelic		(N)	31/01/2019
gn	Guarani		(N)	31/01/2019
he	Hebrew		(N)	31/01/2019
hr	Croatian		(N)	31/01/2019
ht	Haitian, Haitian Creole		(N)	31/01/2019

hu	Hungarian		(N)	31/01/2019
hy	Armenian		(N)	31/01/2019
ia	Interlingua (International Auxiliary Language Association)		(N)	31/01/2019
id	Indonesian		(N)	31/01/2019
is	Icelandic		(N)	31/01/2019
it	Italian		(N)	31/01/2019
ja	Japanese		(N)	31/01/2019
jv	Javanese		(N)	31/01/2019
ka	Georgian		(N)	31/01/2019
km	Central Khmer		(N)	31/01/2019
ko	Korean		(N)	31/01/2019
ku	Kurdish		(N)	31/01/2019
lb	Luxembourgish, Letzeburgesch		(N)	31/01/2019
lo	Lao		(N)	31/01/2019
lt	Lithuanian		(N)	31/01/2019
lv	Latvian		(N)	31/01/2019
mg	Malagasy		(N)	31/01/2019
mk	Macedonian		(N)	31/01/2019
mn	Mongolian		(N)	31/01/2019
mt	Maltese		(N)	31/01/2019
nl	Dutch, Flemish		(N)	31/01/2019
no	Norwegian		(N)	31/01/2019
pl	Polish		(N)	31/01/2019
pt	Portuguese		(N)	31/01/2019
ro	Romanian, Moldavian, Moldovan		(N)	31/01/2019
ru	Russian		(N)	31/01/2019
se	Northern Sami		(N)	31/01/2019
sk	Slovak		(N)	31/01/2019
sl	Slovenian		(N)	31/01/2019
sm	Samoan		(N)	31/01/2019
so	Somali		(N)	31/01/2019
sq	Albanian		(N)	31/01/2019
sr	Serbian		(N)	31/01/2019
sv	Swedish		(N)	31/01/2019
sw	Swahili		(N)	31/01/2019

ta	Tamil		(N)	31/01/2019
th	Thai		(N)	31/01/2019
tr	Turkish		(N)	31/01/2019
uk	Ukrainian		(N)	31/01/2019
ur	Urdu		(N)	31/01/2019
uz	Uzbek		(N)	31/01/2019
vi	Vietnamese		(N)	31/01/2019
zh	Chinese		(N)	31/01/2019

### NT7 - unit of measure (U)

specification of the unit of measure, it is a sub set of table Unit of Measure Code - UN/ECE REC 20 delivered by United Nations Economic Commission for Europe (UN/ECE)

Agency name: eBIZ / UN/ECE

tabella cod.: NT7

File codes list (Generic code): [http://www.ebiz.enea.it/moda-ml/repository/codelist/v2018-1/gc\\_NT7.xml](http://www.ebiz.enea.it/moda-ml/repository/codelist/v2018-1/gc_NT7.xml)

Other link: <http://docs.oasis-open.org/ubl/os-UBL-2.1/cl/gc/default/UnitOfMeasureCode-2.1.gc#>

Code	Description	Adoption note	Version status	Date of insertion
CMK	square centimetre		(N)	20/12/2017
CMQ	cubic centimetre		(N)	20/12/2017
CMT	centimetre			
CNE	centiNewton			
CO2TON	ton of CO2		(N)	10/09/2014
COUPLES	couples			
DMQ	cubic decimetre			
E37	pixel		(N)	11/04/2018
GRM	gram			
HUR	hour			
INH	inch			
KGM	kilogram			
KMT	kilometer			
KWH	kilowatthours		(N)	10/09/2014
LBR	pound			
MIN	minute			
MMK	square millimetre		(N)	20/12/2017

MTK	square metre		(N)	20/12/2017
MTQ	cubic metre			
MTR	metre			
NMB	numero			
ONZ	ounce			
P1	percent			
PPM	parts per milion			
PZ	piece		(U)	
RPM	rounds per metre			
YRD	yard			

### NT71 - picture resolution type (N)

the type of density of the picture

Agency name: eBIZ

tabella cod.: NT71

File codes list (Generic code): [http://www.ebiz.enea.it/moda-ml/repository/codelist/v2018-1/gc\\_NT71.xml](http://www.ebiz.enea.it/moda-ml/repository/codelist/v2018-1/gc_NT71.xml)

Code	Description	Adoption note	Version status	Date of insertion
dpi	dots per inch		(N)	11/04/2018
ppi	pixels per inch		(N)	11/04/2018

### NT72 - picture final use type (N)

the type of final use of the picture

Agency name: eBIZ

tabella cod.: NT72

File codes list (Generic code): [http://www.ebiz.enea.it/moda-ml/repository/codelist/v2018-1/gc\\_NT72.xml](http://www.ebiz.enea.it/moda-ml/repository/codelist/v2018-1/gc_NT72.xml)

Code	Description	Adoption note	Version status	Date of insertion
ICO	online icon		(N)	11/04/2018
IMG	generic online image		(N)	11/04/2018
IML	online image large		(N)	11/04/2018
IMM	online image medium		(N)	11/04/2018
IMS	online image small		(N)	11/04/2018
PRH	high quality printing		(N)	11/04/2018

PRN	printing		(N)	11/04/2018
-----	----------	--	-----	------------

### T1 - terms of payment

code specifying the terms or time by which the payment must be done

Agency name: eBIZ

tabella cod.: T1

File codes list (Generic code): [http://www.ebiz.enea.it/moda-ml/repository/codelist/v2018-1/gc\\_T1.xml](http://www.ebiz.enea.it/moda-ml/repository/codelist/v2018-1/gc_T1.xml)

Code	Description	Adoption note	Version status	Date of insertion
ANTICIP	PAYMENT IN ADVANCE			
BLCOLLECT/120D	BILL OF LADING 120 DD			
BLCOLLECT/30D	BILL OF LADING 30 DD			
BLCOLLECT/60D	BILL OF LADING 60 DD			
BLCOLLECT/90D	BILL OF LADING 90 DD			
CASH	PAYMENT ON DELIVERY			
CASHINV	PAYMENT ON RECEIPT OF INVOICE			
CREDOC/0D	DOCUMENTARY CREDIT FOR PAYM. AT SIGHT			
CREDOC/120	DOCUMENTARY CREDIT FOR PAYM. AT 120 DD			
CREDOC/150	DOCUMENTARY CREDIT FOR PAYM. AT 150 DD			
CREDOC/180	DOCUMENTARY CREDIT FOR PAYM. AT 180 DD			
CREDOC/30D	DOCUMENTARY CREDIT FOR PAYM. AT 30 DD			
CREDOC/45D	DOCUMENTARY CREDIT FOR PAYM. AT 45 DD			
CREDOC/60	DOCUMENTARY CREDIT FOR PAYM. AT 60 DD			
CREDOC/90	DOCUMENTARY CREDIT FOR PAYM. AT 90 DD			
DEL/10	PAYMENT AT 10 DD AFTER DELIVERY			
DOCOLLECT/120D	DOCUMENTARY COLLECTION AT 120 DD			
DOCOLLECT/30D	DOCUMENTARY COLLECTION AT 30 DD			
DOCOLLECT/60D	DOCUMENTARY COLLECTION AT 60 DD			
DOCOLLECT/90D	DOCUMENTARY COLLECTION AT 90 DD			
INV/120D	PAYMENT AT 120 DD AFTER RECEIPT OF INVOICE			
INV/150D	PAYMENT AT 150 DD AFTER RECEIPT OF INVOICE			

INV/180D	PAYMENT AT 180 DD AFTER RECEIPT OF INVOICE			
INV/30D	PAYMENT AT 30 DD AFTER RECEIPT OF INVOICE			
INV/45D	PAYMENT AT 45 DD AFTER RECEIPT OF INVOICE			
INV/60D	PAYMENT AT 60 DD AFTER RECEIPT OF INVOICE			
INV/90D	PAYMENT AT 90 DD AFTER RECEIPT OF INVOICE			
INVULTIMO	PAYMENT AT END MONTH RECEIPT INVOICE			
INVULTIMO/10D	PAYMENT 10 DD AFTER END MONTH RECEIPT INVOICE			
INVULTIMO/120D	PAYMENT 120 DD AFTER END MONTH RECEIPT INVOICE			
INVULTIMO/150D	PAYMENT 150 DD AFTER END MONTH RECEIPT INVOICE			
INVULTIMO/180D	PAYMENT 180 DD AFTER END MONTH RECEIPT INVOICE			
INVULTIMO/240D	PAYMENT 240 DD AFTER END MONTH RECEIPT INVOICE			
INVULTIMO/30D	PAYMENT 30 DD AFTER END MONTH RECEIPT INVOICE			
INVULTIMO/45D	PAYMENT 45 DD AFTER END MONTH RECEIPT INVOICE			
INVULTIMO/60D	PAYMENT 60 DD AFTER END MONTH RECEIPT INVOICE			
INVULTIMO/90D	PAYMENT 90 DD AFTER END MONTH RECEIPT INVOICE			
NOPAY	WITHOUT PAYMENT			
RECREDOC/0D	IRREVOC. DOCUMENTARY CREDIT FOR PAYM. AT SIGHT			
RECREDOC/120D	IRREVOC. DOCUMENTARY CREDIT FOR PAYM. AT 120 DD			
RECREDOC/150D	IRREVOC. DOCUMENTARY CREDIT FOR PAYM. AT 150 DD			
RECREDOC/180D	IRREVOC. DOCUMENTARY CREDIT FOR PAYM. AT 180 DD			
RECREDOC/30D	IRREVOC. DOCUMENTARY CREDIT FOR PAYM. AT 30 DD			
RECREDOC/45D	IRREVOC. DOCUMENTARY CREDIT FOR PAYM. AT 45 DD			
RECREDOC/60D	IRREVOC. DOCUMENTARY CREDIT FOR PAYM. AT 60 DD			
RECREDOC/90D	IRREVOC. DOCUMENTARY CREDIT FOR PAYM. AT 90 DD			
ULTIMO	PAYMENT BY END MONTH OF DELIVERY			

ULTIMO/10	PAYMENT AT 10 DD AFTER END MONTH OF DELIVER Y			
-----------	--	--	--	--

### T10 - ISO3166 - Country

code of the nation

Agency name: ISO

tabella cod.: T10

File codes list (Generic code): [http://www.ebiz.enea.it/moda-ml/repository/codelist/v2018-1/gc\\_T10.xml](http://www.ebiz.enea.it/moda-ml/repository/codelist/v2018-1/gc_T10.xml)

Table not printed: there are 239 elements, more than the maximum specified for printing: 99.

### T11 - transport package type (U)

code specifying the type of package used for transport and delivery (subset of UN/ECE 8053 and UBL TransportEquipmentTypeCode-2.1)

Agency name: eBIZ

tabella cod.: T11

File codes list (Generic code): [http://www.ebiz.enea.it/moda-ml/repository/codelist/v2018-1/gc\\_T11.xml](http://www.ebiz.enea.it/moda-ml/repository/codelist/v2018-1/gc_T11.xml)

Other link: <http://docs.oasis-open.org/ubl/os-UBL-2.1/cl/gc/default/TransportEquipmentTypeCode-2.1.gc#>

Code	Description	Adoption note	Version status	Date of insertion
4A	box, steel		(U)	
4C	box, wood		(U)	
4G	Box, fibreboard		(N)	01/08/2018
4H	Box, plastic		(N)	01/08/2018
5H	Bag, woven plastic		(N)	01/08/2018
5L	Bag, textile		(N)	01/08/2018
5M	Bag, paper		(U)	
AJ	Cone		(N)	01/08/2018
BL	Bale, compressed		(N)	01/08/2018
BN	Bale, non-compressed		(N)	01/08/2018
BX	Box		(U)	
CI	Canister		(N)	01/08/2018
CL	Coil		(N)	01/08/2018
CN	Container, not otherwise specified as transport equipment		(N)	01/08/2018
CS	Case		(N)	01/08/2018
CT	Carton		(N)	01/08/2018

EC	Bag, plastic		(N)	01/08/2018
ED	Case, with pallet base		(N)	01/08/2018
EE	Case, with pallet base, wooden		(N)	01/08/2018
EF	Case, with pallet base, cardboard		(N)	01/08/2018
EG	Case, with pallet base, plastic		(N)	01/08/2018
EH	Case, with pallet base, metal		(N)	01/08/2018
FX	Bag, flexible container		(N)	01/08/2018
HN	Hanger		(N)	01/08/2018
NE	unpacked		(U)	
NF	Unpacked or unpackaged, single unit		(N)	01/08/2018
NG	Unpacked or unpackaged, multiple units		(N)	01/08/2018
OA	Pallet, CHEP 40 cm x 60 cm		(N)	01/08/2018
OB	Pallet, CHEP 80 cm x 120 cm		(N)	01/08/2018
OC	Pallet, CHEP 100 cm x 120 cm		(N)	01/08/2018
OD	Pallet, AS 4068-1993		(N)	01/08/2018
OE	Pallet, ISO T11		(N)	01/08/2018
PE	europallet (80x120)			
PX	pallet		(U)	
QS	box, plastic, solid		(U)	
RJ	Rack, clothing hanger		(N)	01/08/2018
RL	Reel		(N)	01/08/2018
SO	Spool		(N)	01/08/2018
TU	tube		(U)	
XD	bag, plastics film		(U)	
XK	bag,paper, multi-wall, water resistant		(U)	
ZZ	Mutually defined		(N)	01/08/2018

### T19 - fibre type

type of fibre used in a textile product

Agency name: eBIZ

tabella cod.: T19

File codes list (Generic code): [http://www.ebiz.enea.it/moda-ml/repository/codelist/v2018-1/gc\\_T19.xml](http://www.ebiz.enea.it/moda-ml/repository/codelist/v2018-1/gc_T19.xml)

Code	Description	Adoption note	Version status	Date of insertion
AB	abaca			20/08/2018



AC	acetate			
AF	other fibres			
AG	alginic fibre			
AL	alfa			20/08/2018
CA	hemp			
CC	coir (coconut)			20/08/2018
CL	chlorofibre			
CO	cotton			
CU	cuprous			
EA	elastan			
EL	Elastodiene			20/08/2018
FL	fluorofibre			
GI	broom			20/08/2018
GL	textile glass			
HA	hair			20/08/2018
HE	henequen			20/08/2018
HL	mixed linen			
HL	cotton linen union			20/08/2018
JU	jute			
KE	kenaf			20/08/2018
KP	kapoc			20/08/2018
LI	linen			
LY	lyocell			20/08/2018
MA	modacrylic			
MD	modal			
ME	metallized			
MG	maguey			20/08/2018
PA	polyamide			
PB	polyureic			
PC	acrylic			
PE	polyethylene			
PI	paper			20/08/2018
PL	polyester			
PM	polyimide			
PP	polypropylene			

PR	proteic			
PU	polyurethane			
RA	mamie			20/08/2018
SE	silk			
SI	sisal			20/08/2018
SN	sun			20/08/2018
TA	triacetate			
TR	textile residues or unspecified composition			20/08/2018
TV	trivinyll			
VI	viscose			
VY	vinyllal			
WA	angora			
WB	beaver			20/08/2018
WC	cashgora			
WG	vicuna			
WK	camel			
WL	llama			
WM	mohair			
WN	lapin			20/08/2018
WO	wool			
WP	alpaca			
WS	cashmere			
WT	Oteer			20/08/2018
WU	guanaco			
WV	virgin wool			
WY	yack			

## T2 - Modes of payment

way or means of payment

Agency name: eBIZ

tabella cod.: T2

File codes list (Generic code): [http://www.ebiz.enea.it/moda-ml/repository/codelist/v2018-1/gc\\_T2.xml](http://www.ebiz.enea.it/moda-ml/repository/codelist/v2018-1/gc_T2.xml)

Code	Description	Adoption note	Version status	Date of insertion
BB	bank transfer			

IA	collection through Agent			
IS	collection through Forwarder			
RB	bank receipt			
RD	remittance			
SW	bank SWIFT			
TR	bank draft			

## T21 - type of document

type or class to which the referenced document belongs

Agency name: eBIZ

tabella cod.: T21

File codes list (Generic code): [http://www.ebiz.enea.it/moda-ml/repository/codelist/v2018-1/gc\\_T21.xml](http://www.ebiz.enea.it/moda-ml/repository/codelist/v2018-1/gc_T21.xml)

Code	Description	Adoption note	Version status	Date of insertion
BOR	blanket order		(N)	01/02/2018
CAT	Price catalogue - tech sheet			
CEO	Certificate of origin		(N)	13/04/2018
CER	Certificate		(N)	13/04/2018
COC	colour card			
CRN	Credit note			08/09/2017
CTO	Checking order			01/07/2013
CTR	Contract		(U)	
CXF	CxF3 file			01/07/2013
DAD	Darn order			
DDT	ddt			
DEA	Despatch advise			
DER	Despatch request			
DR	Document Request			02/12/2014
FOR	Forecast			02/12/2014
GSO	Garment stock offer			
GSX	Garment stock offer change			
INV	Invoice			
KCC	Knitting-Clothing Commission Order			02/12/2014
KCI	Garment in Work Inventory Report			02/12/2014
M2M	Made to Measure Production Order			02/12/2014

MAS	Master marker			
MCI	Visual merchandising instruction		(N)	13/04/2018
OCH	Order change			
OFF	Offer			
ORD	Purchase order			
ORP	Order response			
OSR	order status request			
OSS	Offer status			02/12/2014
OST	Order status			
OUR	our reference			
QR	Quality Report			02/12/2014
RAI	Raw Material in Work Inventory Report			02/12/2014
RDC	Raw dyeing commission order			
RDH	Raw dyeing order change			
RDR	Raw dyeing order response			
REA	Receiving advise			
REQ	Request for Offer			
RET	Return			02/12/2014
RSC	Spinning commission order			
RSH	Spinning order change			
RSR	Spinning order response			
SCL	process sheet			
TFC	Textile dyeing-finishing commission order			
TFX	Textile Dyeing-Finishing Order Change			02/12/2014
TPC	Textile printing commission order			
TPX	Textile Printing Order Change			02/12/2014
TWI	Textile in work inventory			
VMI	visual merchandising instructions		(N)	01/02/2018
WAC	Warping commission order			
WEC	Weaving commission order			
YDC	Yarn dyeing commission order			
YDH	Yarn dyeing order change			
YDR	Yarn dyeing order response			
YTC	Twisting commission order			
YWI	Yarn in work inventory			

### T29 - type of yarn package

type of package (roll-up) used for a yarn product

Agency name: eBIZ

tabella cod.: T29

File codes list (Generic code): [http://www.ebiz.enea.it/moda-ml/repository/codelist/v2018-1/gc\\_T29.xml](http://www.ebiz.enea.it/moda-ml/repository/codelist/v2018-1/gc_T29.xml)

Code	Description	Adoption note	Version status	Date of insertion
CIL	bobbin			
CON	cone			
HNK	hank, skein			01/07/2013
MUF	muff, cake			01/07/2013
SPL	spool			
TUB	tube			
XCO	supercone			

### T3 - terms of delivery

specification of the terms of trade (INCOTERMS)

Agency name: Incoterms

tabella cod.: T3

File codes list (Generic code): [http://www.ebiz.enea.it/moda-ml/repository/codelist/v2018-1/gc\\_T3.xml](http://www.ebiz.enea.it/moda-ml/repository/codelist/v2018-1/gc_T3.xml)

Cod e	Description	Adoption note	Versi on statu s	Date of insertio n
CF R	COST AND FREIGHT (named port of destination)			
CIF	COST, INSURANCE AND FREIGHT (named port of destination)			
CIP	CARRIAGE AND INSURANCE PAID (named place of destination)			
CP T	CARRIAGE PAID (named place of destination)			
DA F	DELIVERED AT FRONTIER (named place)	according to Incoterms® 2010 it is obsolete		08/12/2017
DA P	Delivered at Place of destination (named place of destination)	according to Incoterms® 2010		08/12/2017

DA T	Delivered at Terminal (named place of destination)	according to Incoterms® 2010		08/12/2017
DD P	DELIVERED DUTY PAID (named place of destination)			
DD U	DELIVERED DUTY UNPAID (named place of destination)	according to Incoterms® 2010 it is obsolete, use DAP		08/12/2017
DE Q	DELIVERED EX-QUAY (named port of destination)	according to Incoterms® 2010 it is obsolete		08/12/2017
DE S	DELIVERED EX-SHIP (named port of destination)	according to Incoterms® 2010 it is obsolete		08/12/2017
EX W	EX WORKS (named place)			
FA S	FREE ALONGSIDE SHIP (named port of shipment)			
FC A	FREE CARRIER (named place)			
FO B	FREE ON BOARD (named port of shipment)			

### T30 - support of yarn package - material

type of material of which a package for yarn is made

Agency name: eBIZ

tabella cod.: T30

File codes list (Generic code): [http://www.ebiz.enea.it/moda-ml/repository/codelist/v2018-1/gc\\_T30.xml](http://www.ebiz.enea.it/moda-ml/repository/codelist/v2018-1/gc_T30.xml)

Code	Description	Adoption note	Version status	Date of insertion
CA	cartoon			
DY	for soft package dyeing			
MT	metallic			01/07/2013
PL	plastic			

### T32 - yarn reel wrapping type

type of wrapping in which a package of yarn is wrapped

Agency name: eBIZ

tabella cod.: T32

File codes list (Generic code): [http://www.ebiz.enea.it/moda-ml/repository/codelist/v2018-1/gc\\_T32.xml](http://www.ebiz.enea.it/moda-ml/repository/codelist/v2018-1/gc_T32.xml)

Code	Description	Adoption note	Version status	Date of insertion
XA	without bag			
XB	paper bag			01/07/2013
XD	plastic film bag			

### T33 - yarn outer packing

code specifying the type of outer wrapping or packing of a yarn

Agency name: eBIZ

tabella cod.: T33

File codes list (Generic code): [http://www.ebiz.enea.it/moda-ml/repository/codelist/v2018-1/gc\\_T33.xml](http://www.ebiz.enea.it/moda-ml/repository/codelist/v2018-1/gc_T33.xml)

Code	Description	Adoption note	Version status	Date of insertion
00				
CB	cartoon box			
CC	cartoon box 18 reels			
CD	cartoon box 36 reels			
XD	plastic film			

### T38 - transport conditions

special condition of transport or special service requested to the Forwarder

tabella cod.: T38

File codes list (Generic code): [http://www.ebiz.enea.it/moda-ml/repository/codelist/v2018-1/gc\\_T38.xml](http://www.ebiz.enea.it/moda-ml/repository/codelist/v2018-1/gc_T38.xml)

Code	Description	Adoption note	Version status	Date of insertion
ACC	arrange customs clearance			
CAL	Carrier loads			
CAU	Carrier unloads			
CMR	CMR carnet			
FFN	freight forwarders national conditions			
FLD	special agreement for full loading			
NCC	do not arrange customs clearance			
PPB	packaging paid by Buyer			
PPS	packaging paid by Supplier			
PRO	proof of delivery			

RFR	return container free			
RPC	return container paid by Customer			
RPS	return container paid by Supplier			
SHL	Shipper loads			
SHU	Consignee unloads			

#### T4 - fabric piece inner packing (wrapping) 1

code specifying the type of inner wrapping/packing used for the fabric piece

Agency name: eBIZ

tabella cod.: T4

File codes list (Generic code): [http://www.ebiz.enea.it/moda-ml/repository/codelist/v2018-1/gc\\_T4.xml](http://www.ebiz.enea.it/moda-ml/repository/codelist/v2018-1/gc_T4.xml)

Code	Description	Adoption note	Version status	Date of insertion
A	Folded, whole width			
B	Folded, doubled			
C	Folded, tube products			
D	Spooled, whole width			
E	Spooled, doubled, pli: left			
F	Spooled, doubled, pli: right			
G	Rolled, whole width, single item			
H	Rolled, whole width, several items			
I	Rolled, doubled			
J	Rolled, tube products			

#### T40 - type of transport means

means of transport, in general or referred to a specific leg

Agency name: eBIZ

tabella cod.: T40

File codes list (Generic code): [http://www.ebiz.enea.it/moda-ml/repository/codelist/v2018-1/gc\\_T40.xml](http://www.ebiz.enea.it/moda-ml/repository/codelist/v2018-1/gc_T40.xml)

Code	Description	Adoption note	Version status	Date of insertion
AIR	aircraft			
SHP	ship			
TRU	truck			



VAN	van			
-----	-----	--	--	--

### T41 - type of Allowance or Charge

coded specification of an Allowance or Charge (elaborated from UNECE 4465)

Agency name: eBIZ

tabella cod.: T41

File codes list (Generic code): [http://www.ebiz.enea.it/moda-ml/repository/codelist/v2018-1/gc\\_T41.xml](http://www.ebiz.enea.it/moda-ml/repository/codelist/v2018-1/gc_T41.xml)

Code	Description	Adoption note	Version status	Date of insertion
1	Agreed settlement		(N)	19/08/2018
10	Costs for draft		(N)	19/08/2018
11	Bank charges	DEPRECATED, use CBK	(N)	19/08/2018
12	Agent commission		(N)	19/08/2018
14	Wrong delivery		(N)	19/08/2018
15	Goods returned to agent		(N)	19/08/2018
16	Goods partly returned		(N)	19/08/2018
17	Transport damage		(N)	19/08/2018
19	Trade discount		(N)	19/08/2018
2	Below specification goods		(N)	19/08/2018
20	Deduction for late delivery	DEPRECATED, use CWB	(N)	19/08/2018
21	Advertising costs		(N)	19/08/2018
22	Customs duties		(N)	19/08/2018
23	Telephone and postal costs		(N)	19/08/2018
24	Repair costs		(N)	19/08/2018
25	Attorney fees		(N)	19/08/2018

26	Taxes		(N)	19/08/2018
3	Damaged goods		(N)	19/08/2018
30	Direct payment to seller		(N)	19/08/2018
32	Goods not delivered		(N)	19/08/2018
33	Late delivery		(N)	19/08/2018
35	Goods returned		(N)	19/08/2018
36	Invoice not received		(N)	19/08/2018
37	Credit note to debtor/not to us		(N)	19/08/2018
38	Deducted bonus		(N)	19/08/2018
39	Deducted discount		(N)	19/08/2018
4	Short delivery		(N)	19/08/2018
40	Deducted freight costs		(N)	19/08/2018
41	Deduction against other invoices		(N)	19/08/2018
42	Credit balance(s)		(N)	19/08/2018
45	Debit note to seller		(N)	19/08/2018
46	Discount beyond terms		(N)	19/08/2018
48	Allowance/charge error		(N)	19/08/2018
49	Substitute product		(N)	19/08/2018
50	Terms of sale error		(N)	19/08/2018
52	Wrong invoice		(N)	19/08/2018
53	Duplicate invoice		(N)	19/08/2018
54	Weight error		(N)	19/08/2018

55	Additional charge not authorized		(N)	19/08/2018
56	Incorrect discount		(N)	19/08/2018
57	Price change		(N)	19/08/2018
58	Variation		(N)	19/08/2018
59	Chargeback		(N)	19/08/2018
65	Settlement to agent		(N)	19/08/2018
66	Cash discount		(N)	19/08/2018
7	Payment on account		(N)	19/08/2018
70	Wrong monetary amount resulting from incorrect free goods quantity		(N)	19/08/2018
72	Temporary special promotion		(N)	19/08/2018
73	Difference in tax rate		(N)	19/08/2018
74	Quantity discount		(N)	19/08/2018
75	Promotion discount		(N)	19/08/2018
76	Cancellation deadline passed		(N)	19/08/2018
77	Pricing discount		(N)	19/08/2018
78	Volume discount		(N)	19/08/2018
79	Sundry discount		(N)	19/08/2018
8	Returnable container charge included		(N)	19/08/2018
9	Invoice error		(N)	19/08/2018
AWA	bonus for works ahead of schedule			
CBK	bank charges			
CCR	servizio di corriere			
CIN	insurance			

CLB	labelling			
CPK	packing			
CSP	special packing			
CW B	penalty for works behind schedule			

#### T421 - size system: nationality

nation or agency identifying the size system

Agency name: eBIZ

tabella cod.: T421

File codes list (Generic code): [http://www.ebiz.enea.it/moda-ml/repository/codelist/v2018-1/gc\\_T421.xml](http://www.ebiz.enea.it/moda-ml/repository/codelist/v2018-1/gc_T421.xml)

Code	Description	Adoption note	Version status	Date of insertion
DE	Germany			
ES	Spain			
EU	Europe			
FR	France			
IT	Italy			
UK	United Kingdom			
US	USA			
XX	International			

#### T422 - size system: market segment

market segment identifying the size system

Agency name: eBIZ

tabella cod.: T422

File codes list (Generic code): [http://www.ebiz.enea.it/moda-ml/repository/codelist/v2018-1/gc\\_T422.xml](http://www.ebiz.enea.it/moda-ml/repository/codelist/v2018-1/gc_T422.xml)

Code	Description	Adoption note	Version status	Date of insertion
B	baby			
C	child			
K	kid			
M	man			
U	unisex			

W	woman			
---	-------	--	--	--

### T423 - size system: base

base of the size system

Agency name: eBIZ

tabella cod.: T423

File codes list (Generic code): [http://www.ebiz.enea.it/moda-ml/repository/codelist/v2018-1/gc\\_T423.xml](http://www.ebiz.enea.it/moda-ml/repository/codelist/v2018-1/gc_T423.xml)

Code	Description	Adoption note	Version status	Date of insertion
1	arab numbers			
2	latin numbers			
3	symbols			
4	letters			
H	height			
L	length			
U	unic			
W	weight			

### T44 - additional code type

qualifier of the additional coding of a product

Agency name: eBIZ

tabella cod.: T44

File codes list (Generic code): [http://www.ebiz.enea.it/moda-ml/repository/codelist/v2018-1/gc\\_T44.xml](http://www.ebiz.enea.it/moda-ml/repository/codelist/v2018-1/gc_T44.xml)

Code	Description	Adoption note	Version status	Date of insertion
CC	colour card			
CL	sales collection			
CO	company identification code		(N)	08/09/2017
DY	dye number			
LT	lot number			
MDI	Made in			08/09/2017
MS	manufacturing state			
PKG	packaging			09/09/2014
PL	product line			

RGB	RGB value			
SE	selvedge code			

### T48 - garment part type

code specifying the type of component or part of a garment (sleeve, neck, ...)

Agency name: eBIZ

tabella cod.: T48

File codes list (Generic code): [http://www.ebiz.enea.it/moda-ml/repository/codelist/v2018-1/gc\\_T48.xml](http://www.ebiz.enea.it/moda-ml/repository/codelist/v2018-1/gc_T48.xml)

Code	Description	Adoption note	Version status	Date of insertion
BB	bottom back		(N)	01/08/2018
BF	bottom fore/front		(N)	01/08/2018
CO	collar		(N)	01/08/2018
CU	cuff		(N)	01/08/2018
DV	fore		(N)	
EM	embroidery		(N)	01/08/2018
OC	other component		(N)	01/08/2018
PO	pocket		(N)	01/08/2018
SC	back		(N)	
SL	sleeve		(N)	01/08/2018
TB	top back		(N)	01/08/2018
TF	top fore/front		(N)	01/08/2018

### T5 - fabric piece inner packing (wrapping) 2

code specifying the sub-type of inner wrapping/packing used for the fabric piece

Agency name: eBIZ

tabella cod.: T5

File codes list (Generic code): [http://www.ebiz.enea.it/moda-ml/repository/codelist/v2018-1/gc\\_T5.xml](http://www.ebiz.enea.it/moda-ml/repository/codelist/v2018-1/gc_T5.xml)

Code	Description	Adoption note	Version status	Date of insertion
A	Open			
B	Folded once, not looped			
C	Folded twice, not looped			
H	Folded once, looped			

I	Folded twice, looped			
J	Without inner object, right side inside			
K	On carton or spooling plank, right side inside			
L	On spool (for pressure sensitive products), right side inside			
M	Without inner object, left side inside			
N	On carton or spooling plank, left side inside			
O	On spool (for pressure sensitive products), left side inside			
P	Without inner object, right side inside (deprecated code)			
Q	On carton, right side inside			
R	On wooden stick, right side inside			
S	Without inner object, left side inside (deprecated code)			
T	On carton, left side inside			
U	On wooden stick, left side inside			

### T6 - fabric piece outer packing

code specifying the type of outer wrapping or packing used for the fabric piece

Agency name: eBIZ

tabella cod.: T6

File codes list (Generic code): [http://www.ebiz.enea.it/moda-ml/repository/codelist/v2018-1/gc\\_T6.xml](http://www.ebiz.enea.it/moda-ml/repository/codelist/v2018-1/gc_T6.xml)

Code	Description	Adoption note	Version status	Date of insertion
0	Not wrapped			
1	Totally wrapped			
2	Wrapped, one side open			
3	Wrapped, both sides open			
4	Wrapped, one side open, with show corner			
5	Wrapped in cartons			
6	Double wrapped			

### T61 - duty or tax or fee type

duty or tax or fee type

Agency name: eBIZ

tabella cod.: T61

File codes list (Generic code): [http://www.ebiz.enea.it/moda-ml/repository/codelist/v2018-1/gc\\_T61.xml](http://www.ebiz.enea.it/moda-ml/repository/codelist/v2018-1/gc_T61.xml)

Code	Description	Adoption note	Version status	Date of insertion
BOL	stamp duty			01/07/2013
CUD	customs duty			01/07/2013
ENV	environmental tax			01/07/2013
FRE	no tax			01/07/2013
OTH	other tax charges			01/07/2013
VAT	value added tax			01/07/2013

### T62 - duty or tax or fee category

duty or tax or fee category

Agency name: eBIZ

tabella cod.: T62

File codes list (Generic code): [http://www.ebiz.enea.it/moda-ml/repository/codelist/v2018-1/gc\\_T62.xml](http://www.ebiz.enea.it/moda-ml/repository/codelist/v2018-1/gc_T62.xml)

Code	Description	Adoption note	Version status	Date of insertion
AA	lower than standard rate			01/07/2013
E	tax not applicable			01/07/2013
H	higher than standard rate			01/07/2013
O	outside scope of tax			01/07/2013
S	standard rate			01/07/2013
Z	zero rate goods			01/07/2013

### T8 - Modes of Transport

way of transport, in general or referred to the specified leg

Agency name: eBIZ

tabella cod.: T8

File codes list (Generic code): [http://www.ebiz.enea.it/moda-ml/repository/codelist/v2018-1/gc\\_T8.xml](http://www.ebiz.enea.it/moda-ml/repository/codelist/v2018-1/gc_T8.xml)

Code	Description	Adoption note	Version status	Date of insertion
1	MARITIME TRANSPORT			
10	Courier			01/07/2013



2	RAIL TRANSPORT			
3	ROAD TRANSPORT			
4	AIR TRANSPORT			
5	MAIL			
6	AIR + SHIP TRANSPORT			
8	INLAND WATER TRANSPORT			
9	MODE UNKNOWN			

**T9 - ISO4217 - Currency**

currency code

Agency name: ISO

tabella cod.: T9

File codes list (Generic code): [http://www.ebiz.enea.it/moda-ml/repository/codelist/v2018-1/gc\\_T9.xml](http://www.ebiz.enea.it/moda-ml/repository/codelist/v2018-1/gc_T9.xml)

Table not printed: there are 205 elements, more than the maximum specified for printing: 99.

## Annex C

### New or changed elements towards previous version

Changes or added elements (changes in description excluded; changes in aggregation notes and best practice included): 400

Test Type	Tag	Status	Item type	Changes related to
Attribute	alternativeText	NEW	alternativeText	Has NEW attribute: In
Attribute	AC_amount	NEW	AC amount	Has NEW attribute: data currency
Element(E)	AC_categoryText	UPDATE	AC category text	Property: Length_Max Old value: 70 New value: 250
Child	acsCode	UPDATE	Accessory code	relationship with child: description  Property: Cardmax Old value: 1 New value: 999
Element(E)	acsCode	UPDATE	Accessory code	Property: class Old value: <i>garment accessory</i> New value: <i>accessory</i>
Child	acsCode	UPDATE	Accessory code	relationship with child: description  Property: Aggregation Note_English Old value: New value: <i>Product description</i>
Attribute	acsPackCode	NEW	Accessory packing code	Has NEW attribute: numbering organisation code
Attribute	acsPackCode	NEW	Accessory packing code	Has NEW attribute: code list reference
Attribute	acsPackCode	NEW	Accessory packing code	Has NEW attribute: code list name
Attribute	acsPackCode	NEW	Accessory packing code	Has NEW attribute: code list version
Element(E)	acsPackCode	UPDATE	Accessory packing code	Property: class Old value: <i>garment accessory</i> New value: <i>accessory</i>
Element(E)	acsPack	UPDATE	Accessory packing details	Property: class Old value: <i>garment accessory</i> New value: <i>accessory</i>

Element(E)	acsPackText	UPDATE	Accessory packing text	Property: Length_Max Old value: 40 New value: 250
Element(E)	acsPackText	UPDATE	Accessory packing text	Property: class Old value: <i>garment accessory</i> New value: <i>accessory</i>
Attribute	additionalIdentifier	NEW	Additional Party Identifier	Has NEW attribute: numbering organisation code
Attribute	additionalIdentifier	NEW	Additional Party Identifier	Has NEW attribute: id Qualifier
Element(I)	additionalComponentCode	NEW	component Code	
Element(I)	additionalIdentifier	NEW	Additional Party Identifier	
Attribute	allowanceCharge	NEW	Allowance and Charge	Has NEW attribute: is Charge
Attribute	allowanceCharge	NEW	Allowance and Charge	Has NEW attribute: maximum quantity
Attribute	allowanceCharge	NEW	Allowance and Charge	Has NEW attribute: minimum quantity
Attribute	allowanceCharge	NEW	Allowance and Charge	Has NEW attribute: data currency
Attribute	allowanceCharge	NEW	Allowance and Charge	Has NEW attribute: unit of measure code
Element(I)	alternativeText	NEW	alternative Text	
Element(E)	art	UPDATE	article identifier	Property: Length_Max Old value: 25 New value: 80
Attribute	art	UPDATE	article identifier	Its attribute: code list reference  Property: Aggregation Note_English Old value: <i>this attribute should be ALTERNATIVE to the others</i> New value: <i>at least one out of this attribute and "numberingOrg" should be set</i>
Element(I)	attachment	NEW	attachment	
Child	attachment	NEW	attachment	Has NEW child of: file name
Child	attachment	NEW	attachment	Has NEW child of: external reference
Child	attachment	NEW	attachment	Has NEW child of: binary object

Attrib	binaryObject	NEW	binary object	Has NEW attribute: encoding
Attrib	binaryObject	NEW	binary object	Has NEW attribute: mime
Attrib	binaryObject	NEW	binary object	Has NEW attribute: format
Attrib	binaryObject	NEW	binary object	Has NEW attribute: character set
Elem(l)	binaryObject	NEW	binary object	
Attrib	brand	NEW	Brand	Has NEW attribute: code list version
Elem(l)	brand	NEW	Brand	
Attrib	brand	NEW	Brand	Has NEW attribute: numbering organisation code
Attrib	brand	NEW	Brand	Has NEW attribute: code list reference
Attrib	brand	NEW	Brand	Has NEW attribute: code list name
Child	buyer	NEW	Buyer (*)	Has NEW child of: Party identifier
Child	buyer	NEW	Buyer (*)	Has NEW child of: Additional Party Identifier
Attrib	buyer	NEW	Buyer (*)	Has NEW attribute: sender Party qualifier
Attrib	catalogPrice	NEW	catalogue price amount	Has NEW attribute: maximum quantity
Attrib	catalogPrice	NEW	catalogue price amount	Has NEW attribute: data currency
Attrib	catalogPrice	UPD ATED	catalogue price amount	Its attribute: minimum quantity  Property: Aggregation Note_English Old value: New value: <i>minimum quantity of product for the application of this price</i>
Elem(l)	characterSetCode	NEW	character set code	
Elem(l)	characterSet	NEW	character set	
Attrib	subClass	NEW	class identifier	Has NEW attribute: code list name
Attrib	class	NEW	class identifier	Has NEW attribute: code list reference
Attrib	macroClass	NEW	class identifier	Has NEW attribute: code list name

Attrib	subClass	NEW	class identifier	Has NEW attribute: code list version
Attrib	class	NEW	class identifier	Has NEW attribute: code list version
Attrib	subClass	NEW	class identifier	Has NEW attribute: code list reference
Attrib	macroClass	NEW	class identifier	Has NEW attribute: numbering organisation code
Attrib	class	NEW	class identifier	Has NEW attribute: numbering organisation code
Attrib	subClass	NEW	class identifier	Has NEW attribute: numbering organisation code
Attrib	class	NEW	class identifier	Has NEW attribute: code list name
Attrib	macroClass	NEW	class identifier	Has NEW attribute: code list reference
Attrib	macroClass	NEW	class identifier	Has NEW attribute: code list version
Elem(l)	class	NEW	class identifier	
Elem(l)	codeQualifier	NEW	code qualifier	
Child	csRange	NEW	color-size range	Has NEW child of: garment variant
Child	csRange	NEW	color-size range	Has NEW child of: drop identifier
Child	csRange	UPDATED	color-size range	relationship with child: articles colour identifier  Property: Aggregation Note_English Old value: New value: <i>used only if not already specified in the article code</i>
Attrib	additional ComponentCode	NEW	component Code	Has NEW attribute: code list reference
Attrib	additional ComponentCode	NEW	component Code	Has NEW attribute: numbering organisation code
Attrib	additional ComponentCode	NEW	component Code	Has NEW attribute: code list version
Attrib	additional ComponentCode	NEW	component Code	Has NEW attribute: code list name
Child	composition	NEW	composition	Has NEW child of: garment composition

Child	composition	NEW	composition	Has NEW child of: description
Element(l)	composition	NEW	composition	
Element(E)	packageContainerN	UPDATE	container reference	Property: Length_Max Old value: 25 New value: 40
Element(l)	conversionRate	NEW	rate	
Element(E)	deliveryPlace	UPDATE	delivery place	Property: Length_Max Old value: 40 New value: 250
Attribute	description	NEW	description	Has NEW attribute: In
Element(E)	description	UPDATE	description	Property: Length_Max Old value: 70 New value: 250
Attribute	despatchDate	NEW	despatch date	Has NEW attribute: date format
Element(l)	despatchDate	NEW	despatch date	
Element(l)	despatchPlace	NEW	despatch place	
Child	productDim	NEW	dimensions	Has NEW child of: height measure
Child	productDim	NEW	dimensions	Has NEW child of: length measure
Child	productDim	NEW	dimensions	Has NEW child of: width measure
Attribute	drop	NEW	drop identifier	Has NEW attribute: numbering organisation code
Attribute	drop	NEW	drop identifier	Has NEW attribute: code list name
Attribute	drop	NEW	drop identifier	Has NEW attribute: code list version
Element(E)	email	UPDATE	e-mail	Property: Length_Max Old value: 80 New value: 250
Element(l)	encodingCode	NEW	encoding code	
Element(l)	encoding	NEW	encoding	
Attribute	extendedDescription	NEW	extended description	Has NEW attribute: In

Element(I)	extended Description	NEW	extended description	
Child	externalReference	NEW	external reference	Has NEW child of: uri
Child	externalReference	NEW	external reference	Has NEW child of: format code
Child	externalReference	NEW	external reference	Has NEW child of: character set code
Child	externalReference	NEW	external reference	Has NEW child of: mime code
Child	externalReference	NEW	external reference	Has NEW child of: encoding code
Element(I)	externalReference	NEW	external reference	
Attribute	fabric	UPD ALTE RATIVE	fabric identifier	Its attribute: code list reference  Property: Aggregation Note_English Old value: <i>this attribute should be ALTERNATIVE to the others</i> New value: <i>at least one out of this attribute and "numberingOrg" should be set</i>
Element(E)	piecePackText	UPD ALTE RATIVE	fabric piece packing text	Property: Length_Max Old value: 40 New value: 250
Element(I)	FASCatalog	NEW	FASCatalog (*)	
Child	FASCatalog	NEW	FASCatalog (*)	Has NEW child of: FC body
Child	FASCatalog	NEW	FASCatalog (*)	Has NEW child of: Trade conditions
Child	FASCatalog	NEW	FASCatalog (*)	Has NEW child of: garment commercial information
Child	FASCatalog	NEW	FASCatalog (*)	Has NEW child of: FC header
Child	fashionProduct	NEW	fashion Product	Has NEW child of: Textiles product code
Child	fashionProduct	NEW	fashion Product	Has NEW child of: Garment part code
Child	fashionProduct	NEW	fashion Product	Has NEW child of: component Code
Child	fashionProduct	NEW	fashion Product	Has NEW child of: general note
Child	fashionProduct	NEW	fashion Product	Has NEW child of: Garment product identifier
Child	fashionProduct	NEW	fashion Product	Has NEW child of: Yarn product code

Child	fashionProduct	NEW	fashion Product	Has NEW child of: Accessory code
Child	fashionProduct	NEW	fashion Product	Has NEW child of: color-size range
Element(l)	fashionProduct	NEW	fashion Product	
Child	FCbody	NEW	FC body	Has NEW child of: FC Group
Child	FCgroup	NEW	FC Group	Has NEW child of: group name
Child	FCgroup	NEW	FC Group	Has NEW child of: garment commercial information
Child	FCgroup	NEW	FC Group	Has NEW child of: general note
Child	FCgroup	NEW	FC Group	Has NEW child of: picture
Child	FCgroup	NEW	FC Group	Has NEW child of: Allowance and Charge
Child	FCgroup	NEW	FC Group	Has NEW child of: extended description
Child	FCgroup	NEW	FC Group	Has NEW child of: FC Item
Child	FCgroup	NEW	FC Group	Has NEW child of: description
Child	FCgroup	NEW	FC Group	Has NEW child of: group identifier
Child	FCgroup	NEW	FC Group	Has NEW child of: reference document details
Child	FCheader	NEW	FC header	Has NEW child of: validity start date
Child	FCheader	NEW	FC header	Has NEW child of: general note
Child	FCheader	NEW	FC header	Has NEW child of: message IT identifier
Child	FCheader	NEW	FC header	Has NEW child of: message currency code
Child	FCheader	NEW	FC header	Has NEW child of: message date
Child	FCheader	NEW	FC header	Has NEW child of: season identifier
Child	FCheader	NEW	FC header	Has NEW child of: Buyer
Child	FCheader	NEW	FC header	Has NEW child of: Supplier



Child	FCheader	NEW	FC header	Has NEW child of: message identifier
Child	FCheader	NEW	FC header	Has NEW child of: picture
Child	FCheader	NEW	FC header	Has NEW child of: reference document details
Child	FCheader	NEW	FC header	Has NEW child of: Third Party
Child	FCheader	NEW	FC header	Has NEW child of: validity end date
Child	FCitem	NEW	FC Item	Has NEW child of: extended description
Child	FCitem	NEW	FC Item	Has NEW child of: unit of measure
Child	FCitem	NEW	FC Item	Has NEW child of: dimensions
Child	FCitem	NEW	FC Item	Has NEW child of: market price
Child	FCitem	NEW	FC Item	Has NEW child of: garment classification
Child	FCitem	NEW	FC Item	Has NEW child of: composition
Child	FCitem	NEW	FC Item	Has NEW child of: line number
Child	FCitem	NEW	FC Item	Has NEW child of: Transport packages details
Child	FCitem	NEW	FC Item	Has NEW child of: measureConversionRate
Child	FCitem	NEW	FC Item	Has NEW child of: general note
Child	FCitem	NEW	FC Item	Has NEW child of: product line
Child	FCitem	NEW	FC Item	Has NEW child of: fashion Product
Child	FCitem	NEW	FC Item	Has NEW child of: reference document details
Child	FCitem	NEW	FC Item	Has NEW child of: garment commercial information
Child	FCitem	NEW	FC Item	Has NEW child of: Allowance and Charge
Child	FCitem	NEW	FC Item	Has NEW child of: tax scheme
Child	FCitem	NEW	FC Item	Has NEW child of: line identifier

Child	FCitem	NEW	FC Item	Has NEW child of: picture
Child	FCitem	NEW	FC Item	Has NEW child of: Brand
Child	FCitem	NEW	FC Item	Has NEW child of: operational code
Child	FCitem	NEW	FC Item	Has NEW child of: product/service name
Element(l)	FCbody	NEW	FC body	
Element(l)	FCgroup	NEW	FC Group	
Element(l)	FCheader	NEW	FC header	
Element(l)	FCitem	NEW	FC Item	
Attribute	fileName	NEW	file name	Has NEW attribute: numbering organisation code
Element(l)	fileName	NEW	file name	
Attribute	fillingCriterion	NEW	filling criterion	Has NEW attribute: progressive number
Element(l)	fillingCriterion	NEW	filling criterion	
Element(l)	formatCode	NEW	format code	
Element(l)	format	NEW	format	
Element(l)	garComInfo	NEW	garment commercial information	
Child	garmentCategory	NEW	garment classification	Has NEW child of: general note
Child	garmentCategory	NEW	garment classification	Has NEW child of: goods Classification
Child	garmentCategory	UPDATED	garment classification	relationship with child: group identifier  Property: Cardmin Old value: 1 New value: 0
Child	garmentCategory	UPDATED	garment classification	relationship with child: sex identifier  Property: Cardmin Old value: 1 New value: 0

Child	garmentCategory	UPDATED	garment classification	relationship with child: sub-group identifier  Property: Cardmin Old value: 1 New value: 0
Child	garmentCodeA	UPDATED	garment code A	relationship with child: description  Property: Cardmax Old value: 1 New value: 999
Child	garmentCodeA	UPDATED	garment code A	relationship with child: description  Property: Aggregation Note_English Old value: New value: <i>Product description</i>
Child	garmentCodeB	NEW	garment code B	Has NEW child of: drop identifier
Child	garmentCodeB	NEW	garment code B	Has NEW child of: garment variant
Child	garmentCodeB	UPDATED	garment code B	relationship with child: description  Property: Aggregation Note_English Old value: New value: <i>Product description</i>
Child	garmentCodeB	UPDATED	garment code B	relationship with child: description  Property: Cardmax Old value: 1 New value: 999
Child	garComInfo	NEW	garment commercial information	Has NEW child of: product specification date
Child	garComInfo	NEW	garment commercial information	Has NEW child of: operational code
Child	garComInfo	NEW	garment commercial information	Has NEW child of: Fabric piece packing details
Child	garComInfo	NEW	garment commercial information	Has NEW child of: yarn presentation details
Child	garComInfo	NEW	garment commercial information	Has NEW child of: project identifier
Child	garComInfo	NEW	garment commercial information	Has NEW child of: requested delivery date

Child	garComInfo	NEW	garment commercial information	Has NEW child of: Brand
Child	garComInfo	NEW	garment commercial information	Has NEW child of: Accessory packing details
Child	garComInfo	NEW	garment commercial information	Has NEW child of: product line
Attribute	garComInfo	NEW	garment commercial information	Has NEW attribute: end use code
Child	garComInfo	NEW	garment commercial information	Has NEW child of: season identifier
Child	garComInfo	NEW	garment commercial information	Has NEW child of: general note
Child	garComInfo	NEW	garment commercial information	Has NEW child of: garment packing
Child	garmentCompos	NEW	garment composition	Has NEW child of: composition rate
Element(E)	garmentMarket	UPDATE	garment market	Property: Tabella_enum Old value: 100 New value:
Element(E)	garmentMarket	UPDATE	garment market	Property: Length_Min Old value: New value: 0
Element(E)	garmentMarket	UPDATE	garment market	Property: Length_Max Old value: New value: 255
Element(E)	garmentMarket	UPDATE	garment market	Property: Enumerazione Old value: Vero New value: Falso
Attribute	garPackCode	NEW	garment packing code	Has NEW attribute: code list name
Attribute	garPackCode	NEW	garment packing code	Has NEW attribute: numbering organisation code
Attribute	garPackCode	NEW	garment packing code	Has NEW attribute: code list version
Attribute	garPackCode	NEW	garment packing code	Has NEW attribute: code list reference
Child	garPack	NEW	garment packing	Has NEW child of: garment packing text
Child	garPack	NEW	garment packing	Has NEW child of: garment packing code

Child	garmentPartCode	NEW	Garment part code	Has NEW child of: articles additional identifier
Child	garmentPartCode	UPDATED	Garment part code	relationship with child: description  Property: Cardmax Old value: 1 New value: 999
Child	garmentPartCode	UPDATED	Garment part code	relationship with child: description  Property: Aggregation Note_English Old value: New value: <i>Product part description</i>
Child	garmentVariant	NEW	garment variant	Has NEW child of: variant code
Child	garmentVariant	NEW	garment variant	Has NEW child of: variant type
Element(l)	garmentComposition	NEW	garment composition	
Element(l)	garmentVariant	NEW	garment variant	
Element(l)	garPackCode	NEW	garment packing code	
Element(l)	garPack	NEW	garment packing	
Element(l)	garPackText	NEW	garment packing text	
Attribute	note	UPDATED	general note	Its attribute: numbering organisation code  Property: Aggregation Note_English Old value: New value: <i>must be used to specify the organization that created the list of codes used in "noteLabel"</i>
Child	geographicArea	NEW	geographic area	Has NEW child of: geographic area code
Child	geographicArea	NEW	geographic area	Has NEW child of: geographic area text
Element(l)	geographicAreaCode	NEW	geographic area code	
Element(l)	geographicArea	NEW	geographic area	
Element(l)	geographicAreaText	NEW	geographic area text	
Child	goodsClassification	NEW	goods Classification	Has NEW child of: class identifier

Child	goodsClassification	NEW	goods Classification	Has NEW child of: class identifier
Child	goodsClassification	NEW	goods Classification	Has NEW child of: class identifier
Element(l)	goodsClassification	NEW	goods Classification	
Attribute	artGroup	UPD ATED	group identifier	Its attribute: code list reference  Property: Aggregation Note_English Old value: <i>this attribute should be ALTERNATIVE to the others</i> New value: <i>at least one out of this attribute and "numberingOrg" should be set</i>
Element(E)	artGroupName	UPD ATED	group name	Property: Length_Max Old value: 70 New value: 80
Child	handlingCharacter	NEW	handling Characteristics	Has NEW child of: general note
Child	handlingCharacter	NEW	handling Characteristics	Has NEW child of: garment packing
Child	handlingCharacter	NEW	handling Characteristics	Has NEW child of: yarn presentation details
Child	handlingCharacter	NEW	handling Characteristics	Has NEW child of: stackability Level
Child	handlingCharacter	NEW	handling Characteristics	Has NEW child of: gross weight measure
Child	handlingCharacter	NEW	handling Characteristics	Has NEW child of: net weight measure
Child	handlingCharacter	NEW	handling Characteristics	Has NEW child of: volume measure
Child	handlingCharacter	NEW	handling Characteristics	Has NEW child of: handling type
Child	handlingCharacter	NEW	handling Characteristics	Has NEW child of: Accessory packing details
Child	handlingCharacter	NEW	handling Characteristics	Has NEW child of: sortable Indicator
Child	handlingCharacter	NEW	handling Characteristics	Has NEW child of: Fabric piece packing details
Attribute	handlingType	NEW	handling type	Has NEW attribute: In
Element(l)	handlingCharacter	NEW	handling Characteristics	
Element(l)	handlingType	NEW	handling type	
Element(l)	idQualifier	NEW	id Qualifier	

Element(l)	isCharge	NEW	is Charge	
Element(l)	isURL	NEW	is URL	
Child	itemIdentification	NEW	item identification	Has NEW child of: serial number
Element(l)	itemIdentification	NEW	item identification	
Child	itemsList	NEW	items list	Has NEW child of: quality level
Child	itemsList	NEW	items list	Has NEW child of: item identification
Attribute	itemsPerPackage	NEW	items per package	Has NEW attribute: unit of measure code
Element(l)	itemsList	NEW	items list	
Element(l)	itemsPerPackage	NEW	items per package	
Element(E)	legalName	UPDATED	Legal name	Property: Length_Max Old value: 80 New value: 250
Element(E)	itemID	UPDATED	line item number	Property: Length_Max Old value: 6 New value: 40
Attribute	lineN	UPDATED	line number	Its attribute: VAT rate  Property: Aggregation Note_English Old value: New value: <i>Deprecated, prefer dtScheme when available.</i>
Element(l)	lineID	NEW	line identifier	
Element(l)	ln	NEW	ln	
Element(l)	macroClass	NEW	class identifier	
Child	marketPrice	NEW	market price	Has NEW child of: Allowance and Charge
Child	marketPrice	NEW	market price	Has NEW child of: geographic area
Child	marketPrice	NEW	market price	Has NEW child of: catalogue price amount
Element(l)	marketPrice	NEW	market price	
Element(l)	maxQty	NEW	maximum quantity	

Element(l)	measureConversion	NEW	measureConversionRate	
Child	measureConversion	NEW	measureConversionRate	Has NEW child of: unit of measure
Child	measureConversion	NEW	measureConversionRate	Has NEW child of: rate
Child	measureConversion	NEW	measureConversionRate	Has NEW child of: unit of measure
Element(l)	measureQualifier	NEW	um qualifier	
Element(l)	mimeCode	NEW	mime code	
Element(l)	mime	NEW	mime	
Attribute	minItemsPerPackage	NEW	minimum items per package	Has NEW attribute: unit of measure code
Element(l)	minItemsPerPackage	NEW	minimum items per package	
Attribute	mod	UPDATED	model identifier	Its attribute: code list reference  Property: Aggregation Note_English Old value: <i>this attribute should be ALTERNATIVE to the others</i> New value: <i>at least one out of this attribute and "numberingOrg" should be set</i>
Attribute	mod	UPDATED	model identifier	Its attribute: numbering organisation code  Property: Aggregation Note_English Old value: <i>this attribute should be ALTERNATIVE to the others</i> New value:
Attribute	nominalHeight	NEW	nominal height measure	Has NEW attribute: unit of measure code
Attribute	nominalWidth	NEW	nominal width measure	Has NEW attribute: unit of measure code
Element(l)	nominalHeight	NEW	nominal height measure	
Element(l)	nominalWidth	NEW	nominal width measure	
Attribute	operationalCode	NEW	operational code	Has NEW attribute: numbering organisation code



Attrib	operationalCode	NEW	operational code	Has NEW attribute: code list reference
Attrib	operationalCode	NEW	operational code	Has NEW attribute: code qualifier
Attrib	operationalCode	NEW	operational code	Has NEW attribute: code list version
Attrib	operationalCode	NEW	operational code	Has NEW attribute: code list name
Element(l)	operationalCode	NEW	operational code	
Attrib	packageModelCode	NEW	package model code	Has NEW attribute: numbering organisation code
Element(e)	packageNumber	UPDATED	package number	Property: Length_Max Old value: 25 New value: 40
Element(l)	packageModelCode	NEW	package model code	
Element(l)	pictureCode	NEW	picture Code	
Child	picture	NEW	picture (*)	Has NEW child of: nominal height measure
Child	picture	NEW	picture (*)	Has NEW child of: picture Code
Child	picture	NEW	picture (*)	Has NEW child of: picture Use
Element(l)	picture	NEW	picture (*)	
Child	picture	NEW	picture (*)	Has NEW child of: picture qualifier
Child	picture	NEW	picture (*)	Has NEW child of: rendering information
Child	picture	NEW	picture (*)	Has NEW child of: nominal width measure
Child	picture	NEW	picture (*)	Has NEW child of: resolution
Child	picture	NEW	picture (*)	Has NEW child of: alternative Text
Child	picture	NEW	picture (*)	Has NEW child of: height measure
Child	picture	NEW	picture (*)	Has NEW child of: width measure
Element(l)	pictureQualifier	NEW	picture qualifier	
Element(l)	pictureUse	NEW	picture Use	

Attrib	productLine	NEW	product line	Has NEW attribute: code list name
Attrib	productLine	NEW	product line	Has NEW attribute: numbering organisation code
Attrib	productLine	NEW	product line	Has NEW attribute: code list reference
Attrib	productLine	NEW	product line	Has NEW attribute: code list version
Element(E)	prodServName	UPDATED	product/service name	Property: class Old value: <i>accessory product/service</i> New value: <i>accessory product-service</i>
Element(I)	productDim	NEW	dimensions	
Element(I)	productLine	NEW	product line	
Element(I)	progr	NEW	progressive number	
Element(E)	project	UPDATED	project identifier	Property: Length_Max Old value: 25 New value: 40
Attrib	qualityLevel	NEW	quality level	Has NEW attribute: numbering organisation code
Attrib	qualityLevel	NEW	quality level	Has NEW attribute: code list reference
Attrib	qualityLevel	NEW	quality level	Has NEW attribute: code list version
Attrib	qualityLevel	NEW	quality level	Has NEW attribute: code list name
Element(I)	qualityLevel	NEW	quality level	
Child	refDoc	NEW	reference document details	Has NEW child of: attachment
Child	refDoc	UPDATED	reference document details	relationship with child: document identifier  Property: BestPractice_English Old value: New value: <i>numberingOrg indicates the role that produced the document identifier (it is allowed to declare two different ones -e.g. customer and supplier - with two docID with different numberingOrg)</i>
Element(I)	rendering	NEW	rendering information	
Element(I)	resolution	NEW	resolution	
Attrib	resolution	NEW	resolution	Has NEW attribute: resolutionType

Element(I)	resolutionType	NEW	resolutionType	
Attribute	season	NEW	season identifier	Has NEW attribute: code list reference
Attribute	season	NEW	season identifier	Has NEW attribute: numbering organisation code
Attribute	season	NEW	season identifier	Has NEW attribute: code list name
Attribute	season	NEW	season identifier	Has NEW attribute: code list version
Attribute	serialIN	NEW	serial number	Has NEW attribute: id Qualifier
Element(E)	serialIN	UPDATED	serial number	Property: Length_Max Old value: 15 New value: 250
Attribute	artSex	UPDATED	sex identifier	Its attribute: code list reference  Property: Aggregation Note_English Old value: <i>this attribute should be ALTERNATIVE to the others</i> New value: <i>at least one out of this attribute and "numberingOrg" should be set</i>
Attribute	size	NEW	size identifier	Has NEW attribute: numbering organisation code
Attribute	size	NEW	size identifier	Has NEW attribute: code list name
Attribute	size	NEW	size identifier	Has NEW attribute: code list version
Child	sizeRow	NEW	size row	Has NEW child of: items list
Child	sizeRow	NEW	size row	Has NEW child of: component Code
Child	sizeRow	UPDATED	size row	relationship with child: drop identifier  Property: Aggregation Note_English Old value: New value: <i>DEPRECATED, anyhow it is used only if not already specified in the article code or csRange</i>
Element(I)	sortableIndicator	NEW	sortable Indicator	
Element(I)	stackabilityLevel	NEW	stackability Level	
Element(I)	subClass	NEW	class identifier	
Element(I)	subDept	NEW	department identifier	

Attrib	artSubGroup	UPD ATE D	sub-group identifier	Its attribute: code list reference  Property: Aggregation Note_English Old value: <i>this attribute should be ALTERNATIVE to the others</i> New value: <i>at least one out of this attribute and "numberingOrg" should be set</i>
Child	supplier	NEW	Supplier (*)	Has NEW child of: Party identifier
Child	supplier	NEW	Supplier (*)	Has NEW child of: Additional Party Identifier
Attrib	supplier	NEW	Supplier (*)	Has NEW attribute: sender Party qualifier
Attrib	legalRef	NEW	tax legal reference	Has NEW attribute: code list name
Attrib	legalRef	NEW	tax legal reference	Has NEW attribute: numbering organisation code
Attrib	legalRef	NEW	tax legal reference	Has NEW attribute: code list version
Attrib	legalRef	UPD ATE D	tax legal reference	Its attribute: code list reference  Property: Use Old value: <i>Required</i> New value: <i>Optional</i>
Child	dtScheme	UPD ATE D	tax scheme	relationship with child: general note  Property: Cardmax Old value: 19 New value: 99
Element(E)	payTermText	UPD ATE D	terms of payment text	Property: Length_Max Old value: 40 New value: 250
Element(E)	incoTermText	UPD ATE D	terms of trade text	Property: Length_Max Old value: 70 New value: 250
Child	texCode	UPD ATE D	Textiles product code	relationship with child: description  Property: Aggregation Note_English Old value: New value: <i>Product description</i>
Child	texCode	UPD ATE D	Textiles product code	relationship with child: description  Property: Cardmax Old value: 1 New value: 999
Child	thirdParty	NEW	Third Party (*)	Has NEW child of: Party identifier

Attrib	thirdParty	NEW	Third Party (*)	Has NEW attribute: sender Party qualifier
Attrib	title	NEW	title	Has NEW attribute: In
Elem(l)	title	NEW	title	
Child	terms	UPDATE	Trade conditions	relationship with child: Transport information  Property: Cardmax Old value: 1 New value: 5
Elem(E)	transConditionText	UPDATE	transport condition - text	Property: Length_Max Old value: 100 New value: 250
Child	transInfo	NEW	Transport information	Has NEW child of: despatch place
Child	transInfo	NEW	Transport information	Has NEW child of: despatch date
Child	transInfo	NEW	Transport information	Has NEW child of: effective delivery date
Attrib	transInfo	NEW	Transport information	Has NEW attribute: progressive number
Elem(E)	packageText	UPDATE	transport package text	Property: Length_Max Old value: 40 New value: 80
Child	packages	NEW	Transport packages details	Has NEW child of: items per package
Child	packages	NEW	Transport packages details	Has NEW child of: minimum items per package
Child	packages	NEW	Transport packages details	Has NEW child of: description
Child	packages	NEW	Transport packages details	Has NEW child of: handling Characteristics
Child	packages	NEW	Transport packages details	Has NEW child of: package model code
Child	packages	NEW	Transport packages details	Has NEW child of: filling criterion
Child	packages	UPDATE	Transport packages details	relationship with child: epc list  Property: Aggregation Note_English Old value: <i>here the RFID tags of the packages can be identified</i>

				New value: <i>this element is DEPRECATED, please use the specific elements</i>
Attrib	unitOfSourceMeasure	NEW	unit of measure	Has NEW attribute: numbering organisation code
Attrib	unitOfTargetMeasure	NEW	unit of measure	Has NEW attribute: code list reference
Attrib	unitOfMeasure	NEW	unit of measure	Has NEW attribute: numbering organisation code
Attrib	unitOfTargetMeasure	NEW	unit of measure	Has NEW attribute: um qualifier
Attrib	unitOfTargetMeasure	NEW	unit of measure	Has NEW attribute: numbering organisation code
Attrib	unitOfSourceMeasure	NEW	unit of measure	Has NEW attribute: code list version
Attrib	unitOfSourceMeasure	NEW	unit of measure	Has NEW attribute: code list reference
Attrib	unitOfTargetMeasure	NEW	unit of measure	Has NEW attribute: code list name
Attrib	unitOfMeasure	NEW	unit of measure	Has NEW attribute: code list name
Attrib	unitOfSourceMeasure	NEW	unit of measure	Has NEW attribute: code list name
Attrib	unitOfTargetMeasure	NEW	unit of measure	Has NEW attribute: code list version
Attrib	unitOfMeasure	NEW	unit of measure	Has NEW attribute: code list reference
Attrib	unitOfMeasure	NEW	unit of measure	Has NEW attribute: um qualifier
Attrib	unitOfMeasure	NEW	unit of measure	Has NEW attribute: code list version
Attrib	unitOfSourceMeasure	NEW	unit of measure	Has NEW attribute: um qualifier
Element(l)	unitOfMeasure	NEW	unit of measure	
Element(l)	unitOfSourceMeasure	NEW	unit of measure	

Element(l)	unitOfTargetMeasure	NEW	unit of measure	
Attribute	uri	NEW	uri	Has NEW attribute: is URL
Element(l)	uri	NEW	uri	
Attribute	variantCode	NEW	variant code	Has NEW attribute: code list version
Attribute	variantCode	NEW	variant code	Has NEW attribute: code list name
Attribute	variantCode	NEW	variant code	Has NEW attribute: numbering organisation code
Attribute	variantCode	NEW	variant code	Has NEW attribute: code list reference
Attribute	variantType	NEW	variant type	Has NEW attribute: code list reference
Attribute	variantType	NEW	variant type	Has NEW attribute: code list version
Attribute	variantType	NEW	variant type	Has NEW attribute: code list name
Attribute	variantType	NEW	variant type	Has NEW attribute: numbering organisation code
Element(l)	variantCode	NEW	variant code	
Element(l)	variantType	NEW	variant type	
Element( E)	yarnOuterPackText	UPDATED	yarn outer packing text	Property: Length_Max Old value: 40 New value: 250
Child	yarnCode	UPDATED	Yarn product code	relationship with child: description  Property: Aggregation Note_English Old value: New value: <i>Product description</i>
Child	yarnCode	UPDATED	Yarn product code	relationship with child: description  Property: Cardmax Old value: 1 New value: 999

## Annex D

### New or changed tables and codes towards previous version

Changes or added items (changes in CodeListAgencyName excluded; changes in adoption notes and code description included): 224

Test Type	Status	Table code	Table description	Code	Change description
Table	UPD ATED	NT 10 0	eBIZ TCFUpstream version		Description_English Old value: <i>eBIZ Moda-ML version</i> New value: <i>eBIZ TCFUpstream version</i>
Code	NEW	NT 10 0		2018-1 (v2018-1)	
Code	NEW	NT 10 0		draft (draft)	
Table	UPD ATED	NT 16	VAT rate or code		Generalities Old value: <i>VAT rate or code ( deprecated, use dtScheme element )</i> New value: <i>VAT rate or code ( DEPRECATED, use dtScheme element )</i>
Code	NEW	NT 2		AU (Auditor)	
Code	NEW	NT 2		CE (Certification authority)	
Code	NEW	NT 2		SC (Sub contractor)	
Code	NEW	NT 2		SM (Service/ePlatform manager)	
Code	NEW	NT 4		SA (Sample)	
Table	UPD ATED	NT 4	end use		Generalities Old value: <i>specifies the final use of the fabric</i> New value: <i>specifies the final use of the product</i>
Table	NEW	NT 43	operational code qualifier		
Code	NEW	NT 43		1 (event)	
Code	NEW	NT 43		2 (sales channel)	



Code	NE W	NT 43		3 (goods management type)	
Code	NE W	NT 43		4 (special initiative)	
Table	NE W	NT 51	Filling Criterion for Package homogeneity		
Code	NE W	NT 51		<i>COL</i> (Colour)	
Code	NE W	NT 51		<i>MOD</i> (Model)	
Code	NE W	NT 51		<i>SIZ</i> (Size)	
Code	NE W	NT 6		<i>EB</i> (eBIZ)	
Code	UPD ATE D	NT 6		<i>ML</i> (DEPRECATED)	adoption_note Old value: New value: <i>DEPRECATED</i>
Table	NE W	NT 60	language, codes from ISO 639-1 (subset)		
Code	NE W	NT 60		<i>F</i> (Female)	
Code	NE W	NT 60		<i>af</i> (Afrikaans)	
Code	NE W	NT 60		<i>ar</i> (Arabic)	
Code	NE W	NT 60		<i>be</i> (Belarusian)	
Code	NE W	NT 60		<i>bg</i> (Bulgarian)	
Code	NE W	NT 60		<i>bn</i> (Bengali)	
Code	NE W	NT 60		<i>bo</i> (Tibetan)	
Code	NE W	NT 60		<i>bs</i> (Bosnian)	
Code	NE W	NT 60		<i>ca</i> (Catalan, Valencian)	
Code	NE W	NT 60		<i>cs</i> (Czech)	
Code	NE W	NT 60		<i>da</i> (Danish)	
Code	NE W	NT 60		<i>de</i> (German)	

Co de	NE W	NT 60		<i>el</i> (Greek, Modern (1453- )	
Co de	NE W	NT 60		<i>en</i> (English)	
Co de	NE W	NT 60		<i>eo</i> (Esperanto)	
Co de	NE W	NT 60		<i>es</i> (Spanish, Castilian)	
Co de	NE W	NT 60		<i>et</i> (Estonian)	
Co de	NE W	NT 60		<i>eu</i> (Basque)	
Co de	NE W	NT 60		<i>fa</i> (Persian)	
Co de	NE W	NT 60		<i>fi</i> (Finnish)	
Co de	NE W	NT 60		<i>fr</i> (French)	
Co de	NE W	NT 60		<i>ga</i> (Irish)	
Co de	NE W	NT 60		<i>gd</i> (Gaelic, Scottish Gaelic )	
Co de	NE W	NT 60		<i>gn</i> (Guarani)	
Co de	NE W	NT 60		<i>he</i> (Hebrew)	
Co de	NE W	NT 60		<i>hr</i> (Croatian)	
Co de	NE W	NT 60		<i>ht</i> (Haitian, Haitian Creole )	
Co de	NE W	NT 60		<i>hu</i> (Hungarian)	
Co de	NE W	NT 60		<i>hy</i> (Armenian)	
Co de	NE W	NT 60		<i>ia</i> (Interlingua (Internation al Auxiliary Language A ssociation))	
Co de	NE W	NT 60		<i>id</i> (Indonesian)	
Co de	NE W	NT 60		<i>is</i> (Icelandic)	
Co de	NE W	NT 60		<i>it</i> (Italian)	

Co de	NE W	NT 60		<i>ja</i> (Japanese)	
Co de	NE W	NT 60		<i>ju</i> (Javanese)	
Co de	NE W	NT 60		<i>ka</i> (Georgian)	
Co de	NE W	NT 60		<i>km</i> (Central Khmer)	
Co de	NE W	NT 60		<i>ko</i> (Korean)	
Co de	NE W	NT 60		<i>ku</i> (Kurdish)	
Co de	NE W	NT 60		<i>lb</i> (Luxembourgish, Letze buresch)	
Co de	NE W	NT 60		<i>lo</i> (Lao)	
Co de	NE W	NT 60		<i>lt</i> (Lithuanian)	
Co de	NE W	NT 60		<i>lv</i> (Latvian)	
Co de	NE W	NT 60		<i>mg</i> (Malagasy)	
Co de	NE W	NT 60		<i>mk</i> (Macedonian)	
Co de	NE W	NT 60		<i>mn</i> (Mongolian)	
Co de	NE W	NT 60		<i>mt</i> (Maltese)	
Co de	NE W	NT 60		<i>nl</i> (Dutch, Flemish)	
Co de	NE W	NT 60		<i>no</i> (Norwegian)	
Co de	NE W	NT 60		<i>pl</i> (Polish)	
Co de	NE W	NT 60		<i>pt</i> (Portuguese)	
Co de	NE W	NT 60		<i>ro</i> (Romanian, Moldavian, Moldovan)	
Co de	NE W	NT 60		<i>ru</i> (Russian)	
Co de	NE W	NT 60		<i>se</i> (Northern Sami)	
Co de	NE W	NT 60		<i>sk</i> (Slovak)	

Co de	NE W	NT 60		<i>sl</i> (Slovenian)	
Co de	NE W	NT 60		<i>sm</i> (Samoan)	
Co de	NE W	NT 60		<i>so</i> (Somali)	
Co de	NE W	NT 60		<i>sq</i> (Albanian)	
Co de	NE W	NT 60		<i>sr</i> (Serbian)	
Co de	NE W	NT 60		<i>sv</i> (Swedish)	
Co de	NE W	NT 60		<i>sw</i> (Swahili)	
Co de	NE W	NT 60		<i>ta</i> (Tamil)	
Co de	NE W	NT 60		<i>th</i> (Thai)	
Co de	NE W	NT 60		<i>tr</i> (Turkish)	
Co de	NE W	NT 60		<i>uk</i> (Ukrainian)	
Co de	NE W	NT 60		<i>ur</i> (Urdu)	
Co de	NE W	NT 60		<i>uz</i> (Uzbek)	
Co de	NE W	NT 60		<i>vi</i> (Vietnamese)	
Co de	NE W	NT 60		<i>zh</i> (Chinese)	
Co de	NE W	NT 7		<i>CMK</i> (square centimetre)	
Co de	NE W	NT 7		<i>CMQ</i> (cubic centimetre)	
Co de	NE W	NT 7		<i>E37</i> (pixel)	
Co de	NE W	NT 7		<i>KWH</i> (kilowatthours)	
Co de	NE W	NT 7		<i>MMK</i> (square millimetre)	
Co de	NE W	NT 7		<i>MTK</i> (square metre)	
Co de	NE W	NT 7		<i>CO2TON</i> (ton of CO2)	

Table	UPD ATE D	NT 7	unit of measure		OtherExternalReferenceURL Old value: New value: <a href="http://docs.oasis-open.org/ubl/os-UBL-2.1/cl/gc/default/UnitOfMeasureCode-2.1.gc#">#http://docs.oasis-open.org/ubl/os-UBL-2.1/cl/gc/default/UnitOfMeasureCode-2.1.gc#</a>
Table	UPD ATE D	NT 7	unit of measure		Description_English Old value: <i>unity of measure</i> New value: <i>unit of measure</i>
Table	NEW	NT 71	picture resolution type		
Code	NEW	NT 71		<i>dpi</i> (dots per inch)	
Code	NEW	NT 71		<i>ppi</i> (pixels per inch)	
Table	NEW	NT 72	picture final use type		
Code	NEW	NT 72		<i>ICO</i> (online icon)	
Code	NEW	NT 72		<i>IMG</i> (generic online image)	
Code	NEW	NT 72		<i>IML</i> (online image large)	
Code	NEW	NT 72		<i>IMM</i> (online image medium)	
Code	NEW	NT 72		<i>IMS</i> (online image small)	
Code	NEW	NT 72		<i>PRH</i> (high quality printing)	
Code	NEW	NT 72		<i>PRN</i> (printing)	
Code	NEW	T1 1		<i>4G</i> (Box, fibreboard )	
Code	NEW	T1 1		<i>4H</i> (Box, plastic )	
Code	NEW	T1 1		<i>5H</i> (Bag, woven plastic )	
Code	NEW	T1 1		<i>5L</i> (Bag, textile )	
Code	UPD ATE D	T1 1		<i>5M</i> (Bag, paper)	Text_English Old value: <i>bag, paper</i> New value: <i>Bag, paper</i>
Code	NEW	T1 1		<i>AJ</i> (Cone )	
Code	NEW	T1 1		<i>BL</i> (Bale, compressed )	

Code	NE W	T1 1		<i>BN</i> (Bale, non-compressed )	
Code	UPD ATE D	T1 1		<i>BX</i> (Box)	Text_English Old value: <i>box</i> New value: <i>Box</i>
Code	NE W	T1 1		<i>CI</i> (Canister )	
Code	NE W	T1 1		<i>CL</i> (Coil )	
Code	NE W	T1 1		<i>CN</i> (Container, not otherwise specified as transport equipment )	
Code	NE W	T1 1		<i>CS</i> (Case )	
Code	NE W	T1 1		<i>CT</i> (Carton )	
Code	NE W	T1 1		<i>EC</i> (Bag, plastic )	
Code	NE W	T1 1		<i>ED</i> (Case, with pallet base )	
Code	NE W	T1 1		<i>EE</i> (Case, with pallet base, wooden )	
Code	NE W	T1 1		<i>EF</i> (Case, with pallet base, cardboard )	
Code	NE W	T1 1		<i>EG</i> (Case, with pallet base, plastic )	
Code	NE W	T1 1		<i>EH</i> (Case, with pallet base, metal )	
Code	NE W	T1 1		<i>FX</i> (Bag, flexible container )	
Code	NE W	T1 1		<i>HN</i> (Hanger )	
Code	NE W	T1 1		<i>NF</i> (Unpacked or unpackaged, single unit )	
Code	NE W	T1 1		<i>NG</i> (Unpacked or unpackaged, multiple units )	
Code	NE W	T1 1		<i>OA</i> (Pallet, CHEP 40 cm x 60 cm )	

Code	NE W	T1 1		<i>OB</i> (Pallet, CHEP 80 cm x 120 cm )	
Code	NE W	T1 1		<i>OC</i> (Pallet, CHEP 100 cm x 120 cm )	
Code	NE W	T1 1		<i>OD</i> (Pallet, AS 4068-1993 )	
Code	NE W	T1 1		<i>OE</i> (Pallet, ISO T11 )	
Code	NE W	T1 1		<i>RJ</i> (Rack, clothing hanger )	
Code	NE W	T1 1		<i>RL</i> (Reel )	
Code	NE W	T1 1		<i>SO</i> (Spool )	
Code	NE W	T1 1		<i>ZZ</i> (Mutually defined)	
Table	UPD ATE D	T1 1	transport package type		OtherExternalReferenceURL Old value: New value: <a href="http://docs.oasis-open.org/ubl/os-UBL-2.1/cl/gc/default/TransportEquipmentTypeCode-2.1.gc#">#http://docs.oasis-open.org/ubl/os-UBL-2.1/cl/gc/default/TransportEquipmentTypeCode-2.1.gc#</a>
Table	UPD ATE D	T1 1	transport package type		Generalities Old value: <i>code specifying the type of package used for transport and delivery</i> New value: <i>code specifying the type of package used for transport and delivery (subset of UN/ED 8053 and UBL TransportEquipmentTypeCode-2.1)</i>
Code	NE W	T2 1		<i>BOR</i> (blanket order)	
Code	NE W	T2 1		<i>CEO</i> (Certificate of origin)	
Code	NE W	T2 1		<i>CER</i> (Certificate)	
Code	UPD ATE D	T2 1		<i>CTR</i> (Contract)	Text_English Old value: <i>contract</i> New value: <i>Contract</i>
Code	NE W	T2 1		<i>MCI</i> (Visual merchandising instruction)	
Code	NE W	T2 1		<i>VMI</i> (visual merchandising instructions)	
Code	NE W	T4 1		<i>1</i> (Agreed settlement)	

Co de	NE W	T4 1		2 (Below specification goods)	
Co de	NE W	T4 1		3 (Damaged goods)	
Co de	NE W	T4 1		4 (Short delivery)	
Co de	NE W	T4 1		7 (Payment on account)	
Co de	NE W	T4 1		8 (Returnable container charge included)	
Co de	NE W	T4 1		9 (Invoice error)	
Co de	NE W	T4 1		10 (Costs for draft)	
Co de	NE W	T4 1		11 (Bank charges)	
Co de	NE W	T4 1		12 (Agent commission)	
Co de	NE W	T4 1		14 (Wrong delivery)	
Co de	NE W	T4 1		15 (Goods returned to agent)	
Co de	NE W	T4 1		16 (Goods partly returned)	
Co de	NE W	T4 1		17 (Transport damage)	
Co de	NE W	T4 1		19 (Trade discount)	
Co de	NE W	T4 1		20 (Deduction for late delivery)	
Co de	NE W	T4 1		21 (Advertising costs)	
Co de	NE W	T4 1		22 (Customs duties)	
Co de	NE W	T4 1		23 (Telephone and postal costs)	
Co de	NE W	T4 1		24 (Repair costs)	
Co de	NE W	T4 1		25 (Attorney fees)	
Co de	NE W	T4 1		26 (Taxes)	



Co de	NE W	T4 1		30 (Direct payment to seller)	
Co de	NE W	T4 1		32 (Goods not delivered)	
Co de	NE W	T4 1		33 (Late delivery)	
Co de	NE W	T4 1		35 (Goods returned)	
Co de	NE W	T4 1		36 (Invoice not received)	
Co de	NE W	T4 1		37 (Credit note to debtor/not to us)	
Co de	NE W	T4 1		38 (Deducted bonus)	
Co de	NE W	T4 1		39 (Deducted discount)	
Co de	NE W	T4 1		40 (Deducted freight costs)	
Co de	NE W	T4 1		41 (Deduction against other invoices)	
Co de	NE W	T4 1		42 (Credit balance(s))	
Co de	NE W	T4 1		45 (Debit note to seller)	
Co de	NE W	T4 1		46 (Discount beyond terms)	
Co de	NE W	T4 1		48 (Allowance/charge error)	
Co de	NE W	T4 1		49 (Substitute product)	
Co de	NE W	T4 1		50 (Terms of sale error)	
Co de	NE W	T4 1		52 (Wrong invoice)	
Co de	NE W	T4 1		53 (Duplicate invoice)	
Co de	NE W	T4 1		54 (Weight error)	
Co de	NE W	T4 1		55 (Additional charge not authorized)	

Co de	NE W	T4 1		56 (Incorrect discount)	
Co de	NE W	T4 1		57 (Price change)	
Co de	NE W	T4 1		58 (Variation)	
Co de	NE W	T4 1		59 (Chargeback)	
Co de	NE W	T4 1		65 (Settlement to agent)	
Co de	NE W	T4 1		66 (Cash discount)	
Co de	NE W	T4 1		70 (Wrong monetary amount resulting from incorrect free goods quantity)	
Co de	NE W	T4 1		72 (Temporary special promotion)	
Co de	NE W	T4 1		73 (Difference in tax rate)	
Co de	NE W	T4 1		74 (Quantity discount)	
Co de	NE W	T4 1		75 (Promotion discount)	
Co de	NE W	T4 1		76 (Cancellation deadline passed)	
Co de	NE W	T4 1		77 (Pricing discount)	
Co de	NE W	T4 1		78 (Volume discount)	
Co de	NE W	T4 1		79 (Sundry discount)	
Ta bl e	UPD ATE D	T4 1	type of Allowance or Charge		Generalities Old value: <i>coded specification of an Allowance or Charge</i> New value: <i>coded specification of an Allowance or Charge (elaborated from UNECE 4465)</i>
Co de	NE W	T4 4		CO (company identification code)	
Co de	NE W	T4 8		BB (bottom back)	
Co de	NE W	T4 8		BF (bottom fore/front)	

Co de	NE W	T4 8		<i>CO</i> (collar)	
Co de	NE W	T4 8		<i>CU</i> (cuff)	
Co de	NE W	T4 8		<i>DV</i> (fore)	
Co de	NE W	T4 8		<i>EM</i> (embroidery)	
Co de	NE W	T4 8		<i>OC</i> (other component)	
Co de	NE W	T4 8		<i>PO</i> (pocket)	
Co de	NE W	T4 8		<i>SC</i> (back)	
Co de	NE W	T4 8		<i>SL</i> (sleeve)	
Co de	NE W	T4 8		<i>TB</i> (top back)	
Co de	NE W	T4 8		<i>TF</i> (top fore/front)	